

FAST

FASTENING & ASSEMBLY SOLUTIONS AND TECHNOLOGY

 **Spirallock**[®]

**KEEPING THREADED JOINTS TOGETHER
WHEN THE HEAT IS ON!**

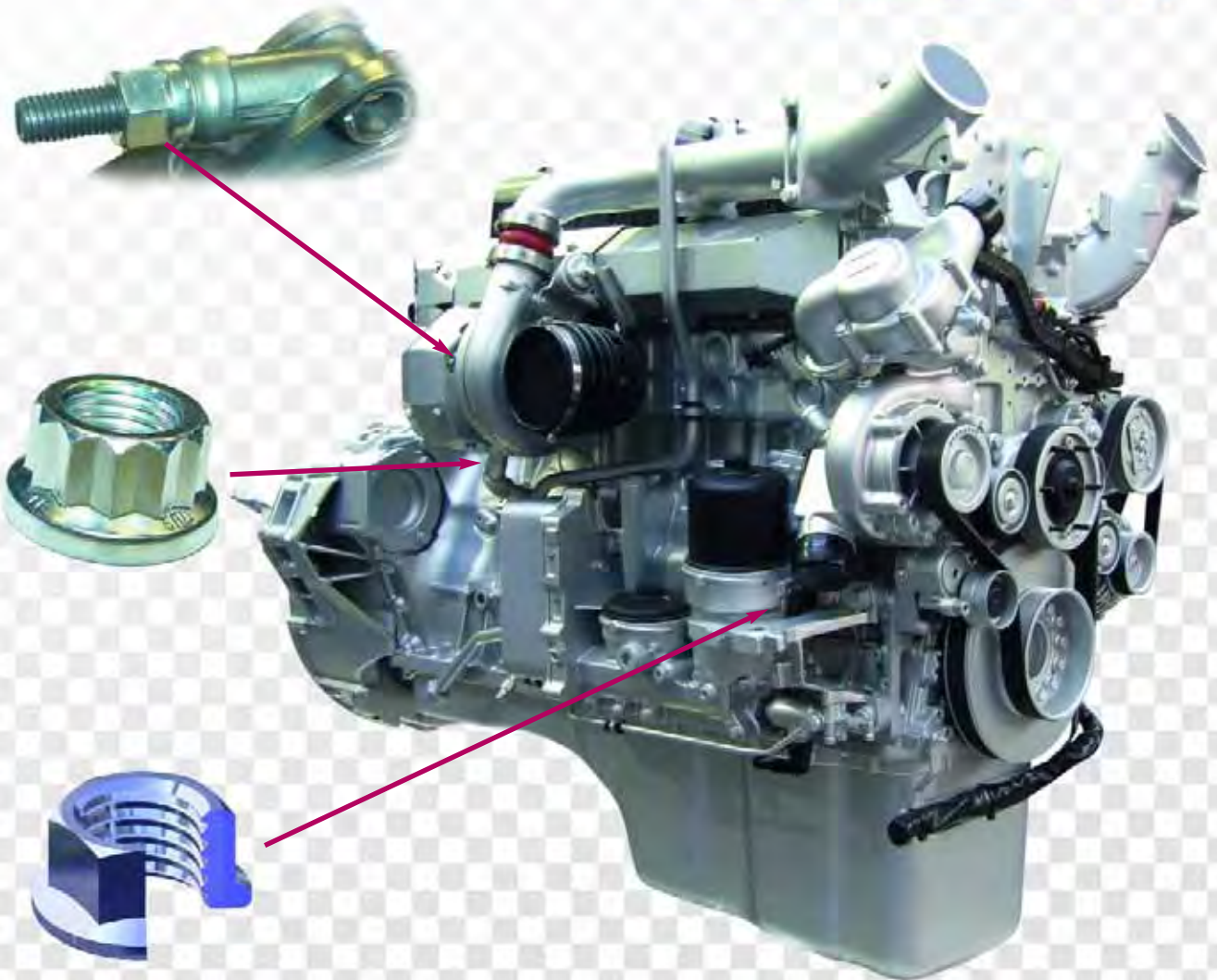

Your Threaded Fastening Solution

EMHART
TEKNOLOGIES

A StanleyBlack&Decker, Inc. Company

OCTOBER 2012

Game over



tesa[®] ACX^{plus}

New tesa ACX^{plus} double sided constructive bonding tapes raise the bar for long term load, stress dissipation, temperature resistance and weatherability performance – even on dissimilar materials and low energy surfaces.

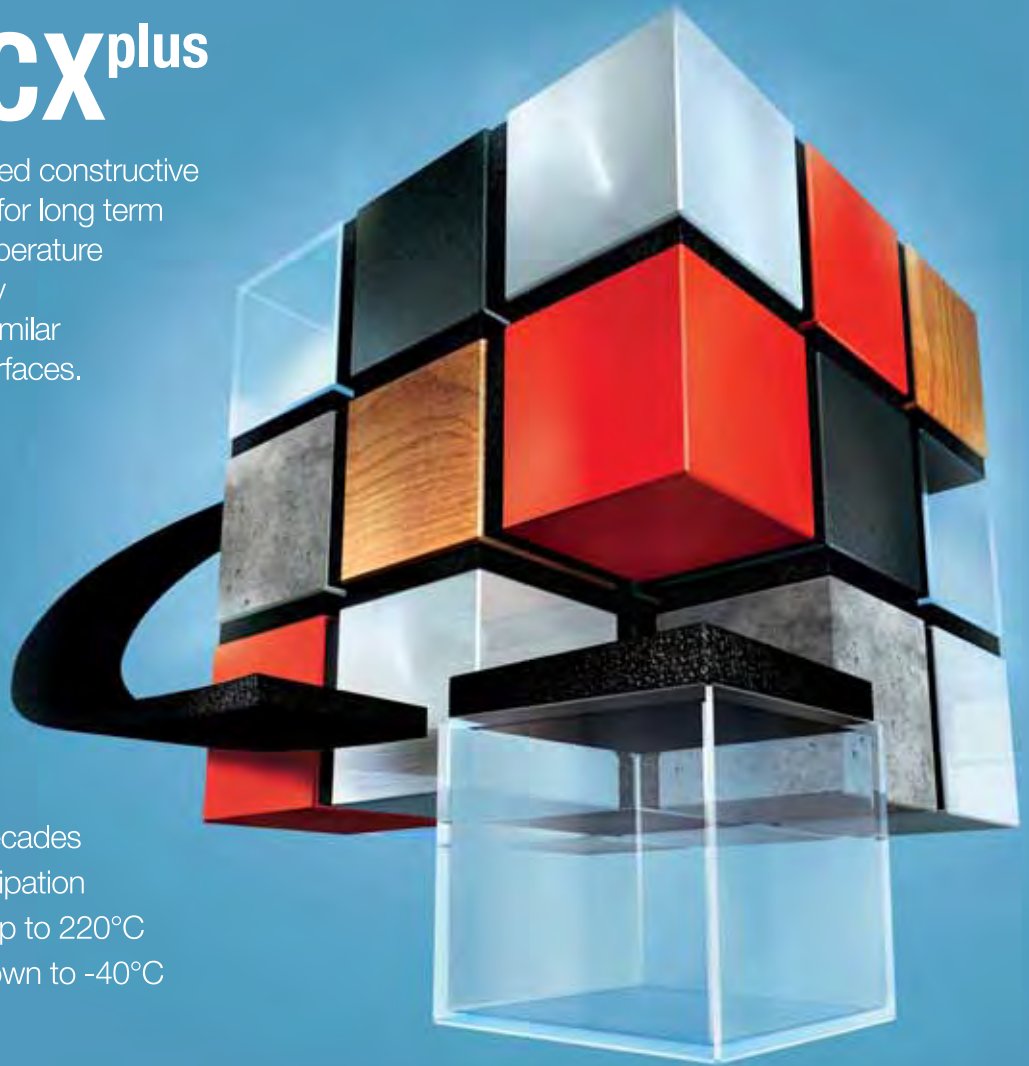

- Very high bond strength
- Life cycle measured in decades
- High load and stress dissipation
- Temperature resistance up to 220°C
- Cold shock resistance down to -40°C
- Outdoor use

Discover tesa ACX^{plus} at www.tesa.co.uk/acx-plus

tesa[®] ACX^{plus} Intelligent Bonding Solutions
It'll change the way you think about tapes

Flat screen mounting | Signage | Window glazing | Elevator reinforcement bars | Facia panels | Automotive exterior parts | Solar modules



tesa UK Ltd

Yeomans Drive Blakelands Milton Keynes MK14 5LS

tel: **01908 500235**

www.tesa.co.uk/acx-plus

www.tesacohesion.co.uk

A tesa Company



tesa cohesion

Head Office
NewbyCom Ltd
Sanderum House, The Sanderum Centre
Oakley Road, Chinnor, Oxon OX39 4TW
Phone: 0845 609 3393
Fax: 0845 280 1587
Email: mark@fastmagazine.co.uk

Editor
Paul Gay
Phone: 07768 596492
Fax: 020 3004 2357
Email: editor@fastmagazine.co.uk

Publishing director
Mark Newby
Phone: 0845 609 3393
Fax: 0845 280 1587
Email: mark@fastmagazine.co.uk

Advertising sales
Harry Price
Phone: 01797 361188
Mobile: 07973 335616
Email: harry@fastmagazine.co.uk

Telesales
Max Camp
Phone: 01844 201381
Fax: 0845 280 1587
Email: max@fastening-solutions.com

Design
John Fisher
Phone: 0845 609 3393
Fax: 0845 280 1587

Production Department
Phone: 0845 609 3393

Reader Service
and Circulation Management
Capsule Publishing Services Ltd
Phone: 0845 602 7390
Fax: 0845 604 2327
Email: circulation@capsule-group.com

Printed by
Headley Brothers Ltd., using vegetable
based inks, supporting responsible use
of forest resources.

FAST makes no charge for the editorial
material which it publishes, unlike many
industrial and technical magazines. This
means that FAST's readers can be assured
that the information which appears on its
editorial pages has been selected by the
editor on the sole grounds that it will be of
interest. Make sure that any publication you
receive carries a similar statement of
editorial policy.

©2012 NewbyCom Limited
FAST (Fastening, Adhesives, Assembly &
Joining Technology) is a controlled
circulation journal published four times a
year. Readers who fulfil the publisher's
criteria and individually request the journal
will receive free copies. Subscriptions from
overseas readers or those who do not qualify
within the terms of the publisher's control
are £56 UK and £86 overseas.
Single copies £12.

No part of this publication may be reproduced, stored
in a retrieval system, or transmitted in any form or by
any means without the prior written permission of the
publisher. Photocopying or the reproduction without
the publisher's permission is in breach of copyright and
action will be taken where this occurs.

FAST October Comment

Why not develop the infrastructure in manufacturing's back yard



The economic soothsayers are warning that without an airport expansion in the Southeast, the future of the UK economy will be, to say the least, bleak. The arguments against an extension to capacity in the London area are multitudinous. Even if the politicians could agree an extension at Heathrow, it is unlikely that the new runway could be built long enough to cope with future generations of airliner, which can only be described as double-decker behemoths. Gatwick apparently has irrevocable planning restrictions until the middle of the century and Stansted is surrounded by Nimbys who won't let anyone build in their back yard.

The objections against the most far-fetched scheme of all – Boris Island, a new build sunk into the Thames Estuary – are coming in by the plane load. Sadly, plans for this project, despite being the most glamorous of all the schemes, are unlikely to develop.

But does Britain need another airport in the Southeast? The financial community would naturally say yes. Without this vital piece of transport infrastructure in place, the City would apparently lose its status in the economic world and financial business would suffer as a result. However, by the time Britain has another airport in the Southeast, the high speed rail network will have been expanded and rail travel up and down the spine of our country will be quick and much improved.

With increased rail capacity running through the centre of the UK, the additional infrastructure needed to service international air travel could be located away from the Southeast. Additional runways could be built at one or more of our regional airports, nearer to the country's manufacturing centres such as the Midlands and the Northwest.

The readers of this magazine will certainly have noted that the manufacturing sector, contrary to the belief of its many critics, contributes substantially to the country's GDP – around 20% at the last count. UK Ltd has not done too badly in these troubled economic times and by the judicial adoption of today's manufacturing techniques, which include the fastening and assembly methods discussed in these pages and exhibited at our exhibi-

tions, will continue to be a major contributor to the British Economy.

A timely moment for a quick mention of the FAST & IASE Exhibitions which take place on October 18th at the National Motorcycle Museum, just a stone's throw from Birmingham International Airport and railway station and most convenient for the national motorway network. A manufacturing event too useful to miss, readers can find out more and register for the shows by clicking <http://www.fastenerexhibition.com>. And a show guide giving much detail is included in this issue starting on page 65.

We've chosen to open our doors early this year to allow visitors wanting an early start to get into the show, get around and get some answers and ideas but still be back in the office by midday or early afternoon. The show is open from 0830hrs and the early birds will be welcomed with a bacon butty and a brew of their choice. Check the website for VIP registration details.

The importance of communications infrastructure is very much in the news at the moment. The British Government believes that being close to an international airport is good for business. And having an airport at the heart of a manufacturing region is bound to be good for industry. Although it may have escaped the notice of bankers and financiers, the manufacturing sector desperately needs airports to satisfy both its international air travel and freight requirements. Why then not build the extra runway capacity we need away from the crowded Southeast and let international travellers complete their journeys by high speed rail link.

The bankers could still jump on a train at Birmingham International or some convenient station to the west of Manchester and get to the City in double quick time via our brand new high speed rail links HS2 and Javelin. By the same token, the manufacturing sector would benefit immensely by improved infrastructure in their back yard.

Paul Gay, Editor
editor@fastmagazine.co.uk

FASTCONTENTS

REGULARS

06 FASTUPDATES

News and comment from the fastening and assembly industry

10 FASTUPDATE ANALYSIS

Fasteners feature green credentials

12 FASTUPDATE ANALYSIS

Manufacturing must automate to accumulate

14 FASTUPDATE CASE STUDY

Increasing production efficiencies through innovative components

17 FASTUPDATE CASE STUDY

Film distributor takes up the challenge



19 FASTUPDATE CASE STUDY

Tapes are becoming increasingly important in the automotive sector

21 FASTUPDATE CASE STUDY

Securing heavy process equipment

22 FASTUPDATE CASE STUDY

In precision engineering, local suppliers can provide the best service

25 FASTUPDATE CASE STUDY

Thread lockers deliver the highest safety standards

26 FASTQ & A

Peter Boote, managing director of Specialty Fasteners & Components, fields the frequently asked questions he receives about Aerocatch, a shear pin latch with its origins in motorsport

52 FASTPRODUCTS

Eight pages of products reviewing the latest announcements in the fastening and assembly systems business

64 FASTQUIZ

There's £100 to be won for the correct answers of the quiz on our Tailpiece page. Sort out some tricky engineering trivia questions and win a cash prize

FASTCOVERSTORY Coping with the heat



Because legal requirements to cut diesel emissions has led to higher operating temperatures, the engine OEMs have had to develop new materials and redesign the fasteners used in these hotter components. By raising diesel engine operating and exhaust temperatures, almost every component in the engine compartment will absorb more heat than originally intended in past designs. Naturally, much research and development has gone into re-engineering engine components to meet these elevated temperatures.

One family of components – that is often one of the last items to be considered in engine designs or upgrades – is fasteners, bolts, screws and nuts that hold together turbo chargers, manifolds, and fuel systems are critical to engine performance and reliability. (See full story on page 31)

SPIRALOCK 01604 827216

FEATURES

28 The Endless Piston Pump

An ideal process involving the application of fluids and liquids would have a pre-determined volume of material applied to a location with accuracy and consistency. This may have more importance in fields like medical device manufacturing or microelectronics

32 Designing a quieter and more economical ride

The drive for more fuel efficient vehicles which retain a good level of performance has led to dramatic reductions in panel weight and a rethink of fastening techniques



35 A secret fixing for decorative panels

An ingenious panel fastener has been developed by a London-based engineering designer. FAST visited Wills Watson Associates' showroom to find out more

37 Blowing in the wind

The sails to be installed in a 50KW vertical axis off shore wind energy turbine prototype have been adhesive bonded to retain the strength and low weight of the composite structure

40 How to: Get the best from press joining and clinching

With today's competitive environment, manufacturers are constantly looking for ways to cut costs without sacrificing quality. The old ways of joining sheet metal components are being replaced by newer technologies

43 Free design service highlights shrink bonding benefits

Ford Motor Company's decision to adopt heat shrink bonding to attach an auxiliary drive gear to the crankshaft of the Volvo S16 engine was supported by a software package that calculates the bond's retaining strength



44 Mass production meets the automotive composites market

Vehicle manufacturers are aggressively adopting lightweight composite material strategies to meet requirements for increased design freedom and flexibility, high strength, stiffness and reduced vehicle weight

46 Top tips: Vehicle assembly systems

Safety systems installed at Kia Motors have reduced downtime in assembly systems by up to 70% in an automotive body complete line

48 Fasteners for the assembly of lightweight vehicles

New high strength lightweight metals, aluminium, plastics, composites and combinations of all these materials, for body-in-white and component applications have spawned a demand for innovative fastening solutions

51 Product Review: Plastic fasteners and components

FAST considers some new developments in this expanding area

65 Show Guide

FAST and IASE Exhibition Preview
Your complete guide to this month's event at the National Motorcycle Museum, Birmingham

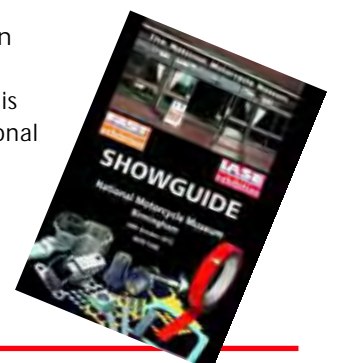

FASTUPDATE



Business Secretary Vince Cable: "UK aerospace industry is a national success story"

Business Secretary Vince Cable led a one-man attack on the 'British curse of short-termism' at the recent Liberal Democrat conference in Brighton.

The solution to this age old problem is apparently a new business bank, which will be set up with public cash, the Business Secretary said. Mr Cable wants to encourage entrepreneurs to



'make things' rather than basing the economy on the mirage of 'property speculation and financial gambling'.

The new bank will use the funds to lend up to £10 billion to companies and it is hoped the move will 'break the stranglehold' of the high street banks, which are often blamed for slowing the economic recovery by refusing to lend.

There have been widespread complaints from small and medium-sized firms that banks are blocking access to finance and hindering their ability to expand.

Mr Cable had a productive month having visited the Farnborough International

Cable plans manufacturing investment

Airshow to launch an investment package to 'keep UK aerospace flying high'. The latest £120 million investment from government and industry in aerospace research and technology was announced alongside a new vision for the future of the sector which is hoped will help UK aerospace firms win billions of pounds worth of new contracts over the next 15 to 20 years.

It will see government and industry working together - under the guise of the Aerospace Growth Partnership (AGP). Mr Cable commented: "The UK aerospace industry is a national success story. We have the top aerospace industry in Europe, and are second in the world only to the US.

"There are great opportunities ahead, with forecasts indicating that 27,000 new large civil airliners will be needed by 2030. We have the potential to grab a greater share of that market - but aerospace is a global industry and there are many other countries hoping to have a slice of the pie.

"That is why the government is doing all it can to make the UK an attractive environment for aerospace - ensuring that companies are more likely to invest in jobs and facilities here with us."

Over £200 million has been pledged by government and industry to keep the UK aerospace sector world class. This includes £120 million of new investment and the £60 mil-



lion previously announced in the Budget for a UK Centre for Aerodynamics.

Included in the scheme are plans for a government and industry investment, involving £40 million each in the Strategic Investment in Low-carbon Engine Technology (SILOET) programme. This Rolls-Royce led programme of low carbon aero engine research will accelerate the development and introduction of low carbon aircraft engine technology. The results from SILOET are expected to deliver a 2% improvement in engine fuel economy and consists of seven projects which will look at lightweight structures, high temperature materials and technology, lean burn systems, virtual engineering tools, and advanced components.

Rees Ward, CEO of Advancing UK AeroSpace, Defence & Security Industries said:

"The UK aerospace industry is in such a strong and leading position due to the sustained investment by government and industry going back decades. With the introduction of the AGP strategy, in the past 18 months, we have already seen tangible results in the £60m investment in a much needed Aerodynamics Centre and the prognosis is for even greater and more substantial returns on our joint investment in the strategy. Such shared commitment to the future of the UK aerospace industry can only help the UK retain its pole position as the leading European exporter to global markets and benefit the economy of this country."



Skill shortage

One of Britain's best-known engineers, Sir James Dyson warned the UK could face a shortage of up to 200,000 engineers within two years and said the Government must do more to promote science, engineering and innovation.

Sir James, was speaking as Dyson revealed that its annual turnover has passed £1bn and profits achieved a record £306m.

The company has become renowned for producing leading-edge technology and employs more than 1,500 scientists and engineers.

Perfect alignment – in line, every time.

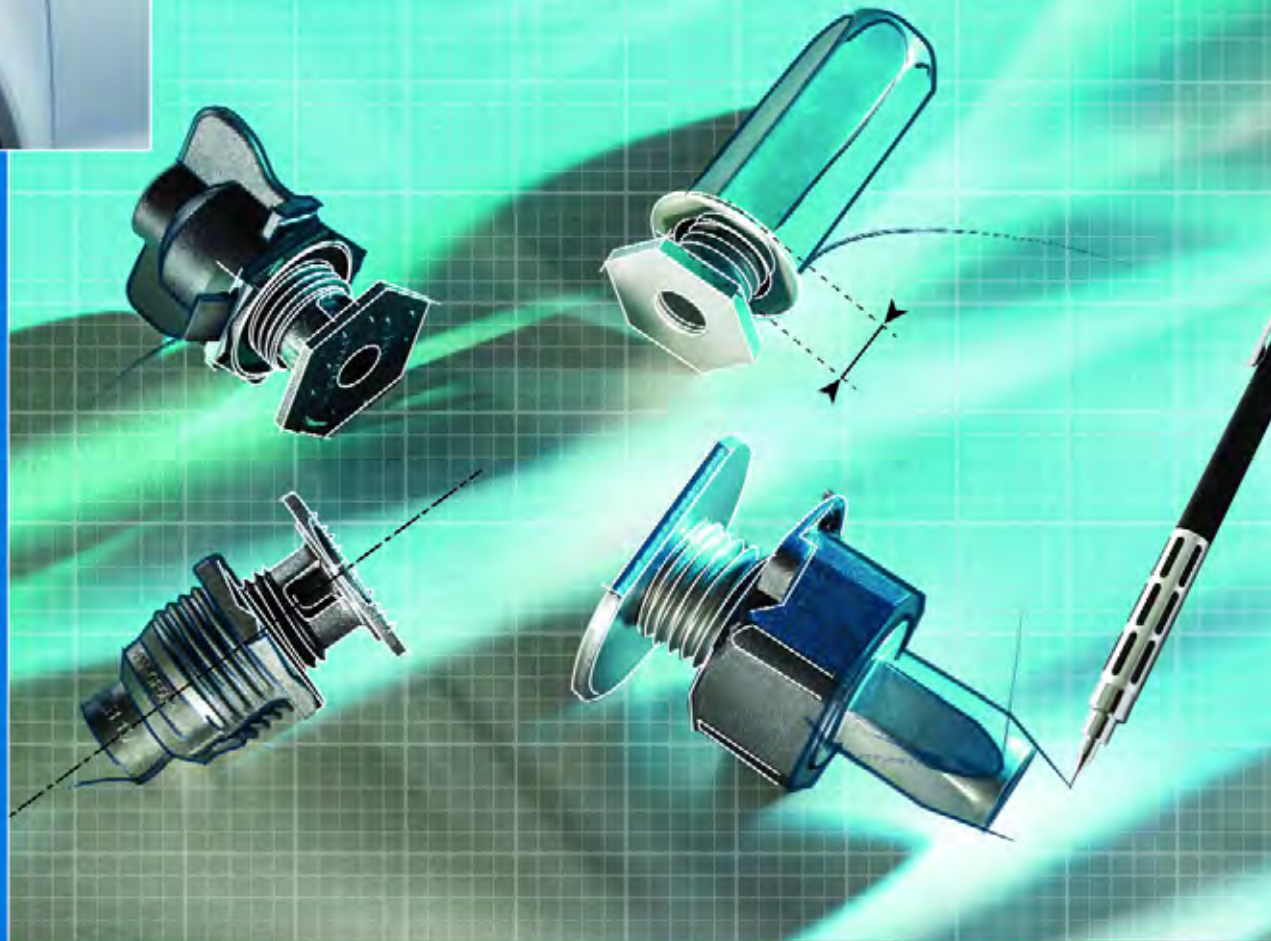

Meet gap engineering requirements, precisely, repeatedly with FLEXITOL stepless tolerance compensation fastener technology.

- Enhance quality
- Add flexibility to assembly operations
- Reduce manufacturing costs
- Lower the cost of outsourced components

BOLLHOFF

Joining together!

Call us today for details.

01902 637161

FASTUPDATES



London's new bus will be built in Northern Ireland

London's latest passenger bus, which has been designed in sympathy with the iconic Routemaster, will be manufactured by Wrightbus in Northern Ireland. The company won a contract in 2009 to build eight prototypes with an option to produce the first 1000 vehicles and now the delivery of up to 600 new buses over the next four years has been approved by the Transport for London Board.

Many components of the new bus, including engines, chassis, superstructure and seats, are manufactured in the UK and will presumably involve some substantial fastening and assembly contracts.

The project represents the largest order of hybrid buses ever placed in Europe and will deliver significant environmental benefits. The 600 buses represent a 200 per cent increase in the current hybrid bus fleet which is set to grow by a further 180 vehicles

already on order. When the final batch of new bus for London vehicles is delivered in 2016 more than 1000 hybrids buses will be in service on the streets of London. The first batch of 30 buses, enough to convert a full route, will enter passenger service in April next year.

Hybrid technology, which combines batteries, a conventional diesel engine and an electric motor to propel the bus was first trialled by TfL in 2006. Hybrid buses typically deliver around a 30 per cent fuel efficiency saving and around 20 per cent reductions in NOx emissions. However, in testing the new bus emitted less than half the CO₂ and NOx of a current diesel bus. The buses also deliver better than twice the fuel economy of a standard diesel bus.

The introduction of the 600 buses will reduce CO₂ emissions in the capital by around 20,600 tonnes a year.

Find the solution to your fastening problems

'Who solved your last fastening and assembly problem?' is a valid question in today's manufacturing environment. There, however, is a good chance that the answer will be one of the top companies exhibiting at this year's FAST & IASE Exhibition on October 18th at the National Motorcycle Museum.

The answer to so many engineering problems today is that teamwork is required to identify, resolve and implement both problems and solutions so the road show format of FAST & IASE has been found to be ideal for development of the relationships and information exchange that minimises time and maximises efficiency in a world which is greatly concerned with cost reduction, introduction of the new technologies and consolidation of the old.

Positioned just outside the NEC, the National Motorcycle Museum will again play host to FAST & IASE with abundant free parking. And the organisers have again arranged for a free bacon roll and brew to be waiting for all pre-registered visitors on arrival, as well as a free museum pass otherwise priced at £8.95.

Exhibitors are expected to focus on low cost fastening in areas including anti-vibration and vibration-proof fasteners, mechanical locking, washers, captive fastening, press joining and clinching, as well as structural adhesives. This will enable



design and production engineers to compare fasteners with a view to reducing assembly costs. Details of this year's participants with stand previews appear in the Show Guide at the back of the magazine.

To be amongst the first to see, discuss and evaluate the latest methods, products, practices and suppliers in industrial fastening, adhesives and assembly, simply go to the exhibition websites and pre-register now!

Entry to FAST & IASE exhibitions is free. One registration provides a badge valid for both events and pre-registration can be done at www.fastenerexhibition.com or www.adhesives-show.com

NEWBYCOM 0845 609 3393



Quarter turn fastening systems meet the Machinery Directive

When considering access panel fastening, the designer will need to make a decision on what type of fastening system to use and to comply with the latest European Machinery Directive. The options are either to go with a quick release fastener system such as the Camloc quarter turn fastener or a conventional nut and bolt. There are pros and cons to both systems and although everyone is familiar with nuts and bolts – although they will need capturing in some way – many engineers are not aware of the benefits of the quarter turn fastener.

Camloc quarter turn fasteners are locked by a 90 degree rotation of the stud into a detent and then unlocked by reversing this. Unlike threaded fasteners they provide a spring-initiated, controlled preload that does not rely on the elasticity of the joined and fastener materials. This allows a very high number of repeated fastening and unfastening cycles. All the components are captivated either in the panel or frame.

The quarter turn fastener is a non-threaded design consisting of a stud assembly, retaining ring and receptacle. The stud assembly has an integral cross pin

which acts as a follower on the cam form of the receptacle. When the stud assembly is rotated, the stud cross pin rides up the receptacle cam causing a controlled joint preload to be applied through the spring in the assembly. This action is accomplished by rotating the stud 90 degrees. At this point the a positive mechanical stop is reached and the cross pin locates into locking detents. The fastener is now securely locked against vibration induced loosening.

SPECIALTY FASTENERS
01803 868677

The fastener assembly partially locked and locked

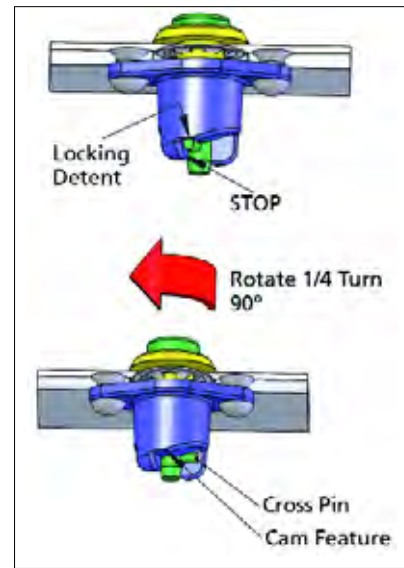

Design considerations for using quarter turn fasteners or threaded bolts and nuts

Quarter-turn fasteners	Threaded bolts/nuts
Frequently Operated	Seldom Operated
Repeatable Performance	Serviceability not a design factor
	More structural in nature
	Limited life if operated often
Quick Accessibility	Disassembly is time consuming
Allows fast removal of access panels	Usually infrequent
Simple to operate	More difficult to operate
User convenience	Multiple turns necessary to install & remove
Controlled joint preload	Variation in preload due to multiple factors
Selection by grip range required	Able to handle large grip ranges
All Fastener Components Captivated	Bolts not easily captivated
Meets Machinery Directive	
Hand or tool operated	Tool operated
Vibration resistant	Relies on thread engagement
	Subject to loosening under vibration
Easy to keep clean and operational	Threads can jam due to ingress of debris
Reduced Service/Maintenance time	Increased service/maintenance time

The Camloc 1/4-Turn Fastener explained

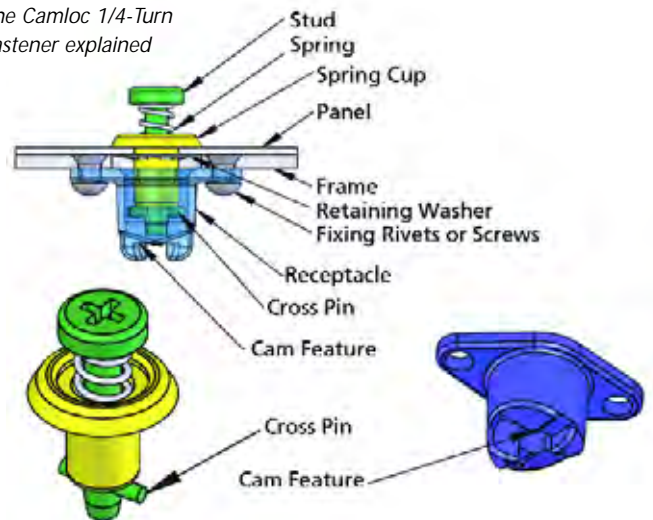

Camloc quarter turn fasteners are available in a wide range of sizes and styles to take loads from 500-10000N and are available with technical support from Specialty Fasteners and Components, which is the authorised UK distributor for Camloc products from Alcoa Fastening Systems



FASTUPDATES ANALYSIS

Fasteners feature green credentials

Ecological demands are driving the need for manufacturers to deliver lighter structures, and products that have a high degree of recyclability. **Roy Hopwood Fasteners** is seeing an increasing trend towards the use of fasteners that possess green credentials. And the distributor believes that leading the way are products within the Ejot Easyboss family.

Originally developed as an alternative for spring steel clips such as U-nuts and J-nuts, the designs have now moved on to deliver multi-functional solutions suitable for a variety of applications. The plastic bosses are placed via a simple press fit,

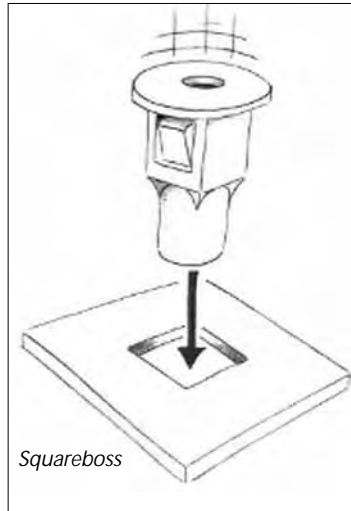

with far greater ease than a metal clip, and have the added advantage of not binding together during transit to the work point. The hole in the mating component is located in line with the hole in the Easyboss, and the joint is secured by installing an Ejot Delta PT screw. Here lies the primary difference between an Easy boss, and a metal clip. The joint is metal within plastic and not metal within metal.

The advantages are numerous. There is little relaxation in the joint, and so sufficient remaining clamp load is maintained for the whole lifetime of the application. The retained clamp load leads the joint to be very capable of withstanding vibration. The lack of metal to metal contact eliminates the risk

of removing or damaging component surface finish.

Originally designed for use in thin plastic sections, where either a boss could not be produced, or a brass insert could not be installed, the Easyboss family is now capable of being placed into a variety of parent materials. The fastest growth area is their use in composite materials such as carbon fibre, where the installation of more traditional fasteners has proved troublesome.

The Easyboss is capable of clipping onto material thicknesses of between 1mm and 6mm, and provides thread engagement between 5mm and 15mm. The Easyboss V is developed for use in components of varying section, or where manufacturing tol-

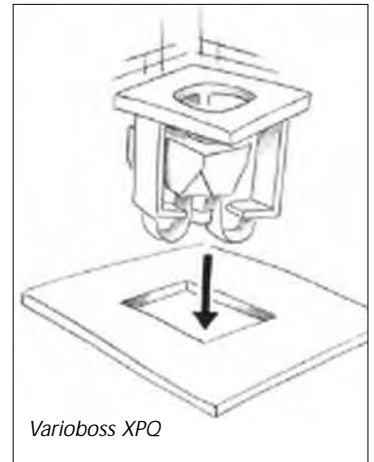

erances are difficult to maintain. The boss is kept in position by two opposed spring elements, thus the Easyboss V remains installed in the component even without the installation of a screw. The Squareboss is the standard solution in the family for smaller installation spaces. The Varioboss is a multifunctional system which accommodates different sheet thicknesses with one component and stays in place without a secondary fixing.

In a nut shell, the Ejot Easyboss family is corrosion resistant, reusable and recyclable. They are quick and easy to install and can save weight. They exhibit tolerance accommodation and resist vibration which leads to prolonged joint life.

ROY HOPWOOD FASTENERS
0845 519 6066

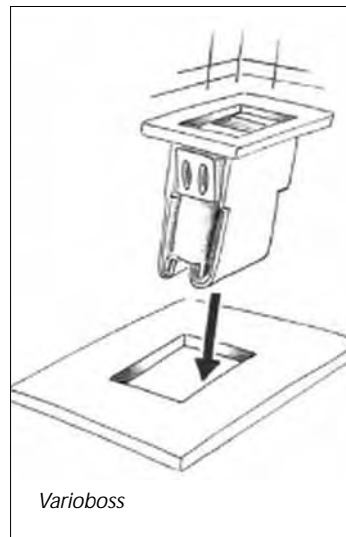
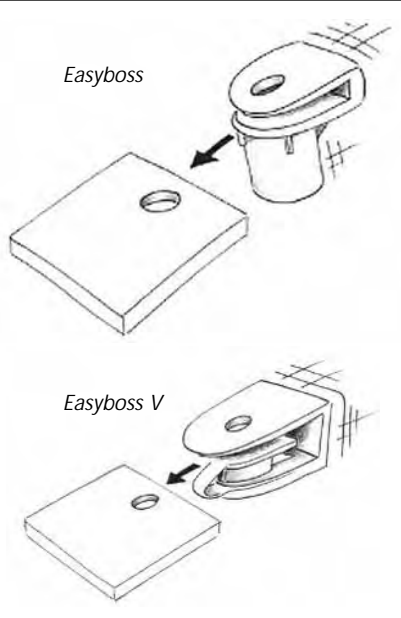

Genuine PEM® Fastening Systems



Genuine PEM® Fasteners and the unique PEMSERTER® presses are the only complete thin-sheet fastener system. Quick, consistent and easy to use, with technical support from the PEM European manufacturing and engineering centre, PEM is the perfect fastening system.

Follow Us on:





70 YEARS OF EXCELLENCE 1942-2012

Ask for genuine PEM® products from your distributor – www.pemnet.com

LOCTITE®

Teroson

Discover Structural Bonding

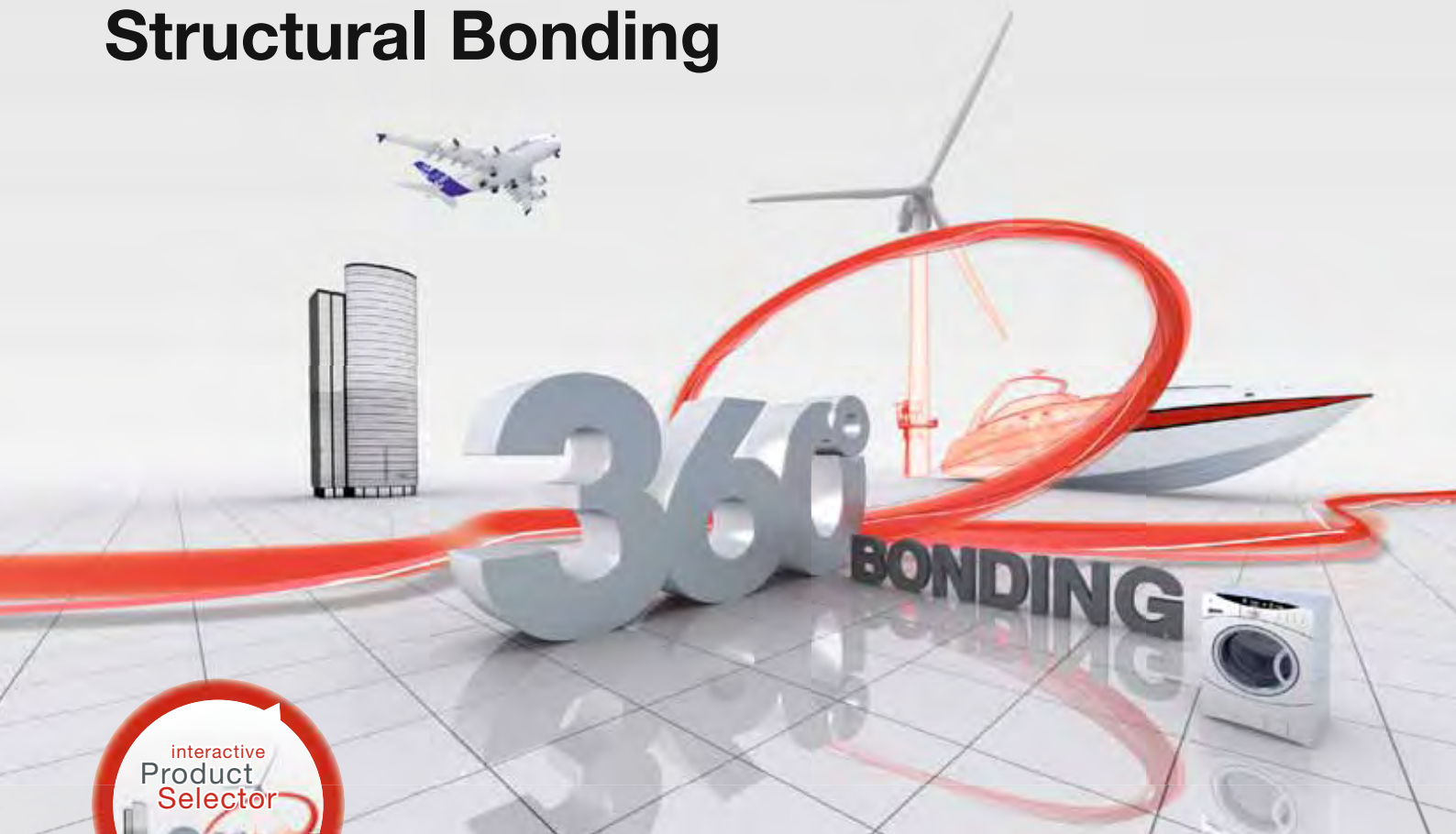

Find your structural bonding solution with the interactive product selector on www.360bonding.com/uk

Class winner in all disciplines

Structural Bonding has become an integral part in today's industrial production processes and offers significant advantages compared to traditional fastening methods. Our entire expertise and product range provide suitable solutions for almost every application. And with our easy to use product selector you can find your structural bonding solution in the twinkling of an eye.

Find more on www.360bonding.com/uk



Excellence is our Passion

FASTNEWS ANALYSIS

BARA demands that we automate to accumulate

If it wasn't impressive enough with sales of robots from January to March 2012 outstripping sales



in any other quarter to date, then sales for the first half of 2012 have now exceeded all previous full year sales on record.

In the first quarter, robot sales of 923 units were recorded which

is larger than the annual total for many of the previous years. The second quarter brought this figure to 2000 for the half year end. However, automotive and automotive component orders contributed 85% of this figure in the first quarter and 89% of the sales in the second. This trend appears to be continuing, at least in the short term. Whilst in most other sectors robot sales are increasing, the growth still remains sluggish and in some sectors in sporadic decline.

Mike Wilson, chairman of the British Automation and Robot Association warned: "While we welcome the level of robot orders from the automotive sector largely driven by product demand in global emerging markets, it is a real concern that other sectors do still not understand the potential implications of not automating. Other countries such as China, Germany and most of the major European manufacturing nations are investing heavily in automation to sustain competitive advantage."

Wilson continued: "Part of the problem in the UK is a short term approach and the perception that the payback period is longer than it often is."

BRITISH AUTOMATION & ROBOT ASSOCIATION 08773 8111

Hybrid fastener specified for Eurocopter

A corrosion resistant, self-locking fastener, capable of providing a load-carrying thread in sheet materials where there is access from one side only, has been created especially for aerospace applications by combining the fastening and aeronautical industry credentials of two well-known Böllhoff products – Rivnut blind rivets and Helicoil wire thread inserts. The fastener has a silver coated Helicoil insert which provides the locking thread for the bolt and prevents binding of the 316L stainless steel bolts extensively used for assembly in the aviation sector.

The product was shown for the first time at last month's Farnborough International Air Show and has been approved for use on Eurocopter, where it provides high resistance to rotation and movement between the alu-

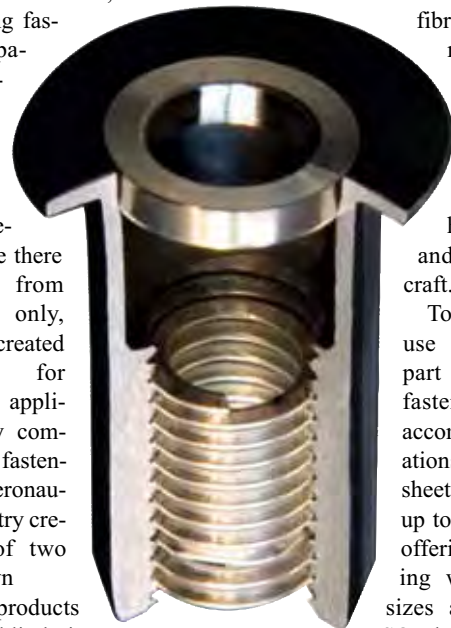

minium and carbon fibre sheet materials widely used in the construction and maintenance of helicopters and other aircraft.

To minimise the use of different part numbers the fastener can accommodate variations in material sheet thickness of up to 2.5mm while offering flush fixing with assorted sizes and types of ISO J bolts.

In use the Rivnut Aero is fail-safe, allowing the bolt to remain the weakest and cheapest component to replace within an assembly.

Installation is quick, easy and repeatable. A hole is created prior to insertion of the Rivnut using proven tooling with depth and torque preset controls. During assembly a mandrel engages with the Helicoil insert and pulls the Rivnut up to form a retaining collar.

BÖLLHOFF ARMSTRONG 01482 325425

gluegunsdirect.com[®]

VISIT US AT GLUEGUNSDIRECT.COM

NORBAR TOTAL TORQUE CONTROL

PRECISION TOOLS FOR
MANUFACTURING AND ASSEMBLY

Norbar equipment is used by world class manufacturers around the globe. All of them see reliability and accuracy as critical to their success. Our aim is to give you peace of mind that your bolted connections have been completed to your requirements.

Our torque wrenches have been developed with the input of customers' engineers, technicians and operators. This has created a product range that is ideal for many standard assembly line applications. Where your needs are more specialised we can work with you to design tooling to give consistent results in your application.

With a range of torque application tools from 1 to 300,000 Nm we have the widest range of torque tools in the world. The entire range is supported by our electronic torque measurement programme and all transducers up to 100,000 Nm can be provided with UKAS accredited certification to ISO 17025 to give you the level of traceability that every modern business will require.

CONTACT US: +44 (0) 1295 753600
sales@norbar.com

Follow us on
twitter

made in
england



Norbar Torque Tools

www.norbar.com

star

FASTENERS

www.starfasteners.co.uk

THE UK'S
LARGEST
DISTRIBUTOR OF



• **HUCK**[®]
FASTENERS



• **QUALITY
RIVETS**



• **THREADED
INSERTS**



• **TOOLING**

- Sales

- Hire

- Repair



Unit 3, Gallows Industrial Estate,
Furnace Road, Ilkeston,
Derbyshire DE7 5EP
T: 0115 932 4939 F: 0115 944 1278
E: sales@starfasteners.co.uk



FASTCASE STUDY

Increasing production efficiencies through innovative components

An innovation in the technology of threaded inserts has led to claimed cuts in installation times by up to 40% for the tangless version of the Kato CoilThread threaded insert, which has been

We spent years developing and perfecting the CoilThread for it to meet the high standards of our design and development team".

Both versions of the threaded inserts are made from cold-rolled stainless steel wire (AS7245), work hardened to a tensile strength above 200,000 psi and a hardness of Rc 43-50. The finished surface is extremely smooth which helps to virtually eliminate friction-induced thread erosion.

The stainless steel that is used to make the product can resist harsh environmental conditions and is suitable for many applications. It can withstand temperatures ranging from -195.6C to 426.7C.

The Kato CoilThread is available in both metric and unified sizes with both versions available in M2 to M12 and their uni-

fied equivalents. The entire range is available in five lengths and materials range from standard stainless steel through Nitronic, Inconel and phosphor bronze as well as plating options including cadmium, dry film lube and silver.

When using the product, a tapped hole is prepared using a standard drill bit which is then countersunk. The hole is then tapped using a screw thread insert (STI) tap. The insert is then installed into the tapped hole. In a free state, the insert is bigger in diameter than the tapped hole. The inserting tool pre-winds the coil to a smaller outside diameter allowing it to enter the tapped thread. When the insert is released from the tool, the insert springs outward, anchoring itself into the tapped hole. With tanged inserts the tang would need to be removed at this stage but the thread is then ready to use.

For tangless inserts the installation process is simple by partially threading the inserts onto the tools' mandrel. The bi-directional design means no time is needed to orientate the insert. Simply align the insert with the tapped hole and press the trigger on the electric tool, after that it's automatic – the insert goes in, the tool comes out and the job is finished.

It is very costly to install an insert into a blind hole, break-off, remove and account for the tang. Some users estimate this cost as high as 30p per tapped hole. Loose tangs not removed can cause costly damage and produc-



CoilThread can be supplied in reels of plastic tape for high volume production



The Kato CoilThread is available in both metric and unified sizes

developed by Advanex Europe a Nottinghamshire based manufacturer of springs, wire forms, pressings and other associated products.

The CoilThread is manufactured at Advantex Europe's site from where it is distributed across Europe, North America, Oceania and Asia via a distribution network. The product comes in either tanged or tangless versions and is used in various sectors including automotive, rail, defence, aerospace and medical device development.

When asked to highlight the rationale behind the product's development, Paul Clifford, managing director explained: "We wanted to help our customers become more efficient in their product assembly and have designed a [component] that reduces installation time, provides full traceability and is compliant with the key aerospace, military development standards.



The inserting tool pre-winds the coil to a smaller outside diameter allowing it to enter the tapped thread

tion down time to expensive electronic and mechanical components. Additionally tangless inserts are easily removed without damage to the customer's expensive parts, unlike conventional tanged inserts, allowing easy service of components. It is also possible to adjust the installation depth of a tangless insert if it were installed too deep or too shallow. This adjustment is not possible with tanged inserts.

The free running, bi-directional inserts provide strong permanent internal threads which resist heat and corrosion. For high volume production, CoilThread can be supplied in reels of plastic tape known as strip feed Inserts. This reduces the need for manual positioning of the inserts.

The standard range of tangless and tanged inserts as well as the necessary tooling can be obtained from the distributor, ASM Fasteners by telephone 0116 2609738 or e-mail: sales@asmfasteners.com

ADVANEX EUROPE
01636 815555

Hinge design for every application

- continuous
- lift-off
- butt and backflap
- special purpose
- heavy-duty

GOLD and WASSALL Quality hinges for over 200 years

01827 63391
www.goldwassalhinges.co.uk



NO

NUTS, BOLTS, COTTER PINS OR TOOLS NEEDED

INTRODUCING SLIC PIN™
THE SELF-LOCKING IMPLANTED COTTER

IT'S LIKE HAVING A PIN AND A COTTER ALL IN ONE!



Protected by patent no. 6,872,039

The quick, easy and secure SLIC Pin incorporates a unique, self-locking, implanted cotter and is ideal for: • blind holes • wherever cotter pin access is limited • automated assembly • and much, much more

More information from our technical sales team:
01803 868677
or visit our website:
www.specialty-fasteners.co.uk

SE SPECIALTY FASTENERS & COMPONENTS
Seymour Wharf, Steamer Quay Road, Totnes, Devon TQ9 5AL

Helicoil®

Precision design and engineering

HELICOIL® thread inserts create **high-strength, wear-free, heat-resistant threads** of the highest precision.



Stoneferry Business Park
Foster Street
Hull HU8 8BT

Tel: +44 (0) 1482 591569
Email: info_bal@bollhoff.com
Web: www.bollhoff-armstrong.co.uk

BOLLHOFF
Armstrong Limited

The Bonding Engineers.

Experienced specialists for innovative and efficient adhesive solutions.



Lohmann Technologies UK Ltd.,
25 Kelvin Drive, Knowlhill,
Milton Keynes MK5 8NH
Telephone: 01296 337 888
info@lohmann-tapes.com
www.lohmann-tapes.com

Lohmann is the global company of choice whenever components need to be joined. As "The Bonding Engineers", we have the experience and the adhesive know-how required to provide you with everything from a single source. From polymerisation and formulation of the adhesive, through coating and converting, to die-cutting and integration into your process. Your benefit? Improved quality, improved efficiency, improved cost-effectiveness.



QUICK RELEASE PINS. EX-STOCK, RELEASED QUICKLY



- Short lead times
- MS, NASM & EN standards
- AGS equivalents
- Quick Release - hand operated
- High shear load capability
- Single action, Double action and Detent styles
- Inch and metric sizes to 65mm dia.

For more information call the SFC technical sales team on
01803 868677 or to view full-range specifications visit
www.specialty-fasteners.co.uk

Specialty Fasteners
& Components Ltd
Seymour Wharf,
Steamer Quay Road,
Tipton, Devon TQ9 6AL



**SPECIALTY
FASTENERS &
COMPONENTS**

Jubilee®



BS 5315
KM06246



ISO 9001
FM00547



T: +44 1634 281 200 E: sales@jubileeclips.co.uk
F: +44 1634 280 101 W: www.jubileeclips.co.uk

Reflective films take up Police challenge



The visual appearance of the markings really interested the police authorities' fleet managers

Based in Clevedon, Somerset, Lakeside Films is a leading supplier to the road traffic and safety sector and stock the appropriate specialist Avery Dennison products, including micro-prismatic Avery Dennison T-7500 MVP (Maximum Visual Performance) reflective and fluorescent sheeting, and Avery Dennison HV 1302 REV metallised reflective films. With a carefully-selected platform of five certified specialist converters, Lakeside Films decided to promote these particular products as practical, cost-effective solutions for emergency vehicle markings in today's quality-conscious, but cost-conscious, marketplace.

Lakeside Films' managing director Scott Horne, who has much experience in the self-adhesive signage and graphics industry, considered that the best way to achieve real market penetration was to work directly with the police authorities, and to conduct trials that would prove the efficacy of the films in direct comparison with other solutions.

Using the specifications created by the scientific development branch of the UK police as a starting point, Lakeside Films set up formal long-term trials with two UK police authorities. "The aim was to create a market awareness that there are real performance differences between products available in the emergency vehicle markings market – and to convince the fleet managers of the police authorities that the Avery Dennison materials that we stock offer a better cost/performance ratio over the whole life of the vehicles," said Horne. "We knew we could prove it."

Working with their certified converters, Lakeside Films created markings using the chosen Avery Dennison films for a total of 12 emergency

service vehicles within the vehicle fleets of their two partner police authorities, and embarked on field trials of the materials that were to last 12-18 months.

"While the ultimate visual appearance and day-time/night-time visibility of the markings were what really interested the police authorities' fleet managers, we were just as concerned to prove the Avery Dennison retro-reflective materials in terms of conversion, finishing, reflectivity values, and resistance to water ingress," continued Horne.

"AveryDennison T-7500 MVP fluorescents and Avery Dennison HV 1302 REV retro-reflective films are high-performance, micro-prismatic products, offering exceptional convenience and

economy in conversion – and the only such products available for emergency vehicle markings. Omni-directional films mean that the chevron markings can be neatly nested on the signshop plotter to save waste – up to 7-10% of material costs. And because there are no visually-dead spots in the films' construction, they are brighter once applied – both by day and by night. These factors, including the use of an appropriate edge seal where required, are also part of the police specification."

The trials have been an unqualified success. Horne concluded: "The fleet managers of both police authorities loved the end results, both visually and in terms of the financial savings they represent. Both authorities have both now switched their material specification to Avery Dennison."

AVERY DENNISON GRAPHICS AND REFLECTIVE SOLUTIONS
+31 65 382 2601



Two police authorities were involved in the reflective film field trials

tried&trusted



Images courtesy Fisker Automotive

This is the fantastic new Fisker Karma hybrid electric sports car.

Boasting a revolutionary drivetrain delivering a huge 959ftlb of torque, a 0-60 time of 6.3 seconds and a top speed of 125 miles per hour, the lightweight aluminium body structure requires absolute strength, rigidity and reliability to handle the high stresses imposed.

Fisker rely on Henrob self-pierce fastening technology to provide the structural integrity necessary to cope with this highly demanding and ground-breaking vehicle concept.

Henrob self-piercing rivets are used, together with adhesives, throughout the body structure to join a wide range of aluminium sheet and extrusion.

Henrob self-pierce fastening systems integrate seamlessly into manual or automated production lines.

With a cycle time similar to spot welding, but without the heat, sparks or fumes, it's no wonder that Henrob self-pierce riveting is becoming the fastening method of choice for forward thinking manufacturers around the world.

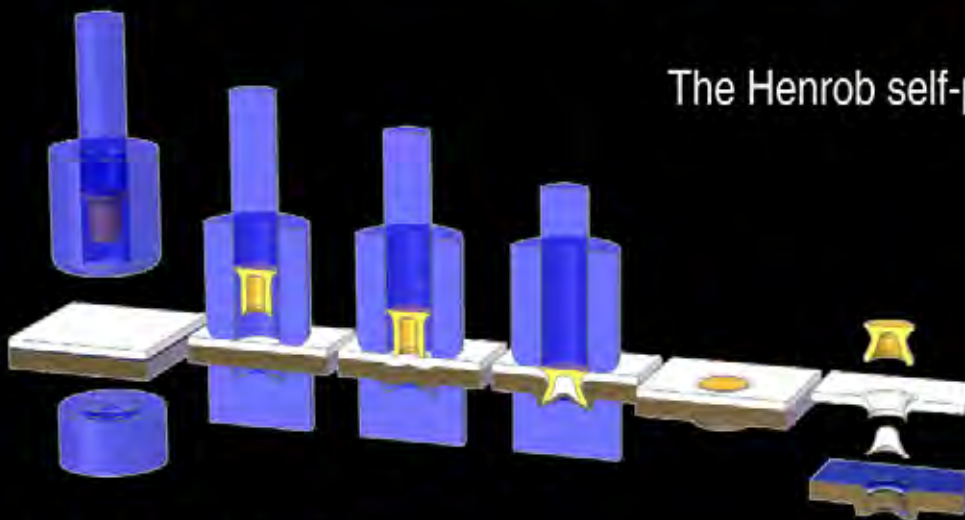

The Henrob self-pierce riveting process

Convenient ✓

Simple ✓

Quick ✓

Clean ✓

Interested?

Find out more at www.henrob.com

Henrob Limited
Second Avenue, Zone 2,
Deeside Industrial Park,
Flintshire CH5 2NX
Tel: +44(0)1244 837220
email: sales@henrob.co.uk

Henrob®
Innovative Joining Solutions

Adhesive tapes have become increasingly important in the automotive sector

As exterior designs in the automotive sector have become more alike from model to model, vehicle interiors have become more important in defining one brand from the next. Demands for high quality interiors, especially in relation to a vehicle's acoustic characteristics, aesthetic appeal and functional performance have become a major differentiator.

High quality designs are at a premium as are industry drives to keep costs and vehicle weight down, while maintaining safety standards. As a result, the industry is increasingly looking at new, more cost-efficient materials and processes and adhesive tapes are starting to play a leading role in this ever-growing market.



Tapes used to protect and bundle wire harnesses must be highly resistant to wear

Permanent protection

A wide range of exterior parts requires the reliable bonding of individual components as well as permanent attachment to the vehicle. A comprehensive range of double-sided tapes from tesa are being used in the sector for mounting exterior parts as they offer good resilience to external factors such as moisture, UV radiation and temperature fluctuations.

The secure bonding of different materials is also needed in the

interior, for example on the headliner, in the seats, or on the dashboard. With single and double sided tapes, tesa is helping automotive designers respond to the latest trends and bring their interior designs to life, providing secure bonding on the diverse substrates often used in interiors, while ensuring noise damping - an essential element in guaranteeing customer satisfaction, product differentiation and elimination of re-working costs.

A prerequisite of driving comfort and a recognised feature of quality is being able to drive without background noises. tesa offers a range of specially developed products that prevent vibrations, squeaking and rattling to deliver high quality standards.

Tapes play a major role in application across the entire bodywork of a car. For example, for vehicle identification numbers (VIN), certification, service, security or warning and instruction information, tesa offers a range of automotive laser labels with customer-specific visible and hidden security features that can be integrated into the labels to maximise security against tampering.

The self-adhesive solutions used to seal holes in the car body are more efficient and cost-effective than the plastic plugs which are traditionally used. They are suitable for every process stage in vehicle production and offer outstanding puncture resistance, noise damping properties, maximum flexibility for uneven surfaces, excellent PVC and paint compatibility and high temperature resistance.

Products used to protect and bundle wire harnesses in the engine must be highly resistant



tesa has been responsible for bundling between two and five kilometres of wiring built into a car since the 1960s

to wear, temperature and chemicals. tesa's range of wire harnessing tapes fulfils this function, offering good flexibility for easy installation, secure bundling and sound-proofing features to prevent rattles.

Jeremy Smith, marketing manager for tesa commented: "The innovative Sleeve range offers excellent flexibility for wire harnesses and contributes significantly to optimising processes and increased efficiencies in their manufacture. As the global market leader, tesa has been responsible for bundling between two and five kilometres of wiring built into a car since the end of the 1960s."

Temporary protection

Interior and exterior vehicle surfaces, including clear coats, plastics and metals, need to be clean and undamaged and require protection during the various stages of production, assembly and transportation.

Providing the necessary tem-

porary protection against a variety of environmental influences and keeping interior surfaces spotlessly clean, tesa Automotive's wide range of pressure-sensitive surface protection tapes also enhance process efficiencies, being easy to remove and disposed of in an ecologically-friendly way.

Temporary product solutions protect delicate surfaces and ensure precise paint jobs, enabling quick and easy application and swift removal without leaving any residue. Design masking tapes create precise paint edges in two-tone designs and paint masking tapes cover surfaces during standard and repair painting.

In the future, adhesive tape technology is expected to take over functions and tasks that go beyond the scope of their traditional role of holding things together.

TESA
01908 500235



PRECISION ENGINEERED COMPONENTS & FASTENERS



First Components Limited

First Components supply machined parts and assemblies using the latest CNC technology. As a component manufacturer we are experienced in turnkey projects, have sub contract expertise and have the experience to project manage contracts from conception to completion.

Savigny Oddie Limited

Savigny Oddie manufacture and supply a comprehensive range of quick release fasteners and associated hardware which include the Oddie fastener, latches, hinges and handles etc.

Our modern equipped manufacturing facility allows us to design, prototype and deliver product to customer specification and timeframes.



Services include:

- Design
- Toolmaking
- Wire Erosion
- CNC Turning
- CNC Milling
- Wire Cutting and Forming
- Laser Cutting
- Pressbrake
- Power Presses
- Fabrication
- Metal Finishing
- Assembly



**FIRST
COMPONENTS
LIMITED**

**SAVIGNY
ODDIE LIMITED**

Wallows Industrial Estate, Wallows Road, Brierley Hill, West Midlands DY5 1QA

Tel: +44 (0)1384 262068
Fax: +44 (0)1384 482383
Email: info@firstcomponents.co.uk
www.firstcomponents.co.uk

Tel: +44 (0)1384 481598
Fax: +44 (0)1384 482383
Email: info@oddiefasteners.co.uk
www.savigny-oddie.co.uk

Securing heavy process equipment

RotaBolt measurement fasteners over 3 metres long are being used for the first time for foundation bolting on a new process gas compressor. The large hyper compressor which weighs 210 tons is manufactured by Burckhardt Compression in Switzerland and is used in the production of low density polyethylene. It is over 11 metres wide by 6 metres long and is secured to a special concrete plinth by fifteen M130 RotaBolts.

The use of control measurement on the compressor's foundation bolting was specified to Burckhardt Compression by their client, one of the world's largest oil and gas companies.

"The requirement to use a control system in the bolting led us to RotaBolt," commented design engineer Daniel Altorfer. "This was new ground for us and RotaBolt's technical team were very helpful during the design and development process. We are now using their fasteners on a second compressor for the same client and we will be closely monitoring performance to see if this technology could become a standard fit for us in the future."

The measurement technology developed by RotaBolt ensures that the correct design tension, or clamping force, is accurately achieved across the joint at installation and then maintained throughout its life. Establishing the correct design tension is critical in assuring the reliability and safety of any bolted joint.

The RotaBolt range provides the user with either finger-tip, visual or remote measurement of tension throughout the life of bolted joints. It is the tension across a bolted joint that is critical to ensuring reliability and safety.

The compressor's foundation bolts are arranged in five rows of three and secure the crankcase housing to the special concrete plinth. Each Burckhardt compressor is required to undergo an annual maintenance check and the design of the RotaBolt can dramatically speed up routine maintenance checking as the RotaCap on the head of the fastener can be instantly finger-checked to see if it is still locked and that the desired tension is being maintained.

JAMES WALKER ROTABOLT
01384 214 442



The RotaBolt design can dramatically speed up routine maintenance checking on this hyper compressor from Burckhardt Compression

button-fix™
the secret fixing for panels



A secret, secure and highly configurable fixing system for panels of any thickness...



Simply versatile...

Configure the fixings to suit your application, engaging vertically, sideways or with a straight push-fit.

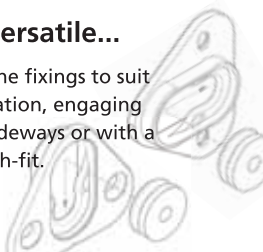

Fitter friendly...

With Button-fix, panels can be installed with ease and efficiency. Our helpful Button marker makes fitting on site simple and precise too!



To find out more...

Email Button-fix at info@button-fix.com, visit our website, www.button-fix.com, call us direct on +44 (0)20 8150 7190 or follow us on twitter at www.twitter.com/buttonfixjulie

FASTCASE STUDY

In precision engineering, local suppliers can provide the best service

Paul Gay talked to Carl Wakelam and Barry George, the ambitious management team at First Components - Savigny Oddie in the West Midlands which is supplying the locking mechanism for the latest Truckman hardtop

First Components - Savigny Oddie provides precision engineering and presswork to a wide range of industries including aerospace, automotive, medical through to electrical, white goods and general engineering. The key to its success, the company claims, lies in the versatility of

has redesigned the locking mechanisms on its latest range of Truckman hardtops, which are available this autumn.

The hardtops have gained so much popularity with 4X4 and pick-up owners that production is running high and to keep the product up-to-date, the design is

parts which could be designed and prototyped by neighbouring companies, servicing the contract in a quick and efficient manner.

“What we needed was a number of metal components sourced locally – from areas like Cheltenham, Gloucester, and the Black Country,” commented Richard Langman, purchasing director at Auto Styling UK. “We were looking for a better locking design but needed it to be sourced locally.”

Enter First Components - Savigny Oddie, based in the West Midlands with processing capabilities which include CNC turning and milling, presswork, wire cutting and forming, wire erosion and tool making and design.

The company took the brief for the new design for the locking of Truckman hardtops, engineered the components and then made working prototypes. Once tested and agreed, it then supplied all the necessary components for the manufacture of the new range.

First Components and Savigny Oddie are both family owned businesses. Savigny Oddie was formed to buy the Ross Courtney brand of quarter-turn fasteners which are used widely in the aerospace industry

and were particularly used for fixing removable panels on the World War II Spitfire.

The quarter-turn business will look after applications where panels need to be removed in operation or for servicing. This simple requirement makes them essentially flexible and available to a broad diversity of industry. The fasteners will fix seats in trains, panels on street lamps, tractor hood covers, industrial panels, enclosures and machine guards; thinking of that list, virtually any volume industry where panels are required to be demountable.

Minimum order is 50 units but the maximum number considered would be around 5 million. Most of the quarter turn fasteners manufactured by the company are designed for 10,000 operations and work out at around 50p a unit. They can be tool operated with a slam-shut spring return mechanism or simply hand operated.

Seven out of ten customers visiting the factory become customers. They discuss the application and approve the design and samples are often made later that same day. The majority of samples then grow into orders of between 200 and 1000 units. When visitors pass through the machine shops, they are faced with a bank of CNC lathes on the one side of the building and an equally impressive line of machining centres on the other. To marshal production and ensure efficiency, all machines are equipped with screens offering design and production information from a Datatrack MRP system, which enables just-in-



Components made in the West Midlands can satisfy local requirements

its CNC machines and the local recruitment of skilled engineers and machinists.

A case in point is component supply contract for the recent redesign of the popular Truckman hardtop for SUVs and pickups. Auto Styling UK has been producing the hardtops at its Dudley factory since 2008 and

under continual improvement review. And perhaps this is the reason the company wins prizes for the manufacture of these popular accessories.

When it came to sourcing components for the locking mechanism for the latest Truckman design, Auto Styling wanted to use locally sourced

Auto Styling UK was founded in 2002 and has become a specialist supplier of 4x4 accessories with a wealth of market and technical knowledge. Its mission is to develop as the fastest growing UK quality supplier of aftermarket 4x4 Pick Up and SUV accessories. The company says it only stocks products that meet stringent quality requirements. The Truckman brand was acquired in 2008 when manufacture was transferred to Dudley. Auto Styling Truckman is today renowned for quality and service and has a hard earned reputation for building the toughest hard tops on the market. Constructed using the strongest materials these tops have been tested in the harshest environments, from arctic expeditions to war zones, proving their strength and reliability.

time operation of raw materials in and finished product out.

Because of the nature of the production system, the team is happy to replicate special fasteners as used on vehicles and aeroplanes being restored. Recent specials produced with little fuss include fasteners for BSA motorcycles, equipment for Austin Healey sports cars and of course replacements for the original

quarter-turn used on the Spitfire engine panels.

Coming back to modern times, quarter-turns are used extensively by the railway industry. Bombardier fixes many of its seats and removable panels with various Savigny Oddie products. And London Underground fixes its seats with the Oddie 8mm snap fit fasteners fitted with a hex head so that a special tool is required to remove them. Cooper Lighting is another important customer using the fasteners to fix panels on its lighting equipment.

An interesting design tweak which enhances the cosmetics of the fastening system is colour coded fasteners which match their surroundings. The heads are colour coated white for lighting products and NATO green for Ministry of Defence work.

Managing director Carl Wakelam is convinced that growth will come from a broad range of customised manufac-

tured components and once the home market kicks in, much of this growth will come from European distribution. But the key here is representation: "We really need sales engineers on the road," said Wakelam.

Naturally, the company can produce many other fasteners as well as locks, toggle latches, hinges and handles. First Components - Savigny Oddie manufactures the emergency window handle for London Transport's double decker buses and then there's the ever popular push/pull fasteners for furniture and some automotive applications. So far in 2012, the company has completed the purchase of an adjacent 7000 sq ft property to expand the original 14,000 sq ft factory. This expansion formed part of a £500,000 investment which also included lathes, milling machines and a 12-axis machining centre to equip the new production space. There are now 42 employees and sales

FASTCASE STUDY



Auto Styling UK has redesigned the locking mechanism on its Truckman hardtop

have grown to £4 million per annum.

Projects like the Truckman hardtop lock are a perfect example of how local supply of specialist components manufactured in a modern versatile factory will pay dividends in the future.

For further information, contact Barry George, sales and marketing director at:

FIRST COMPONENTS - SAVIGNY ODDIE
07967 478917



Truckman tops are made in Britain from locally sourced components

Starlock® PUSH-ON FASTENERS



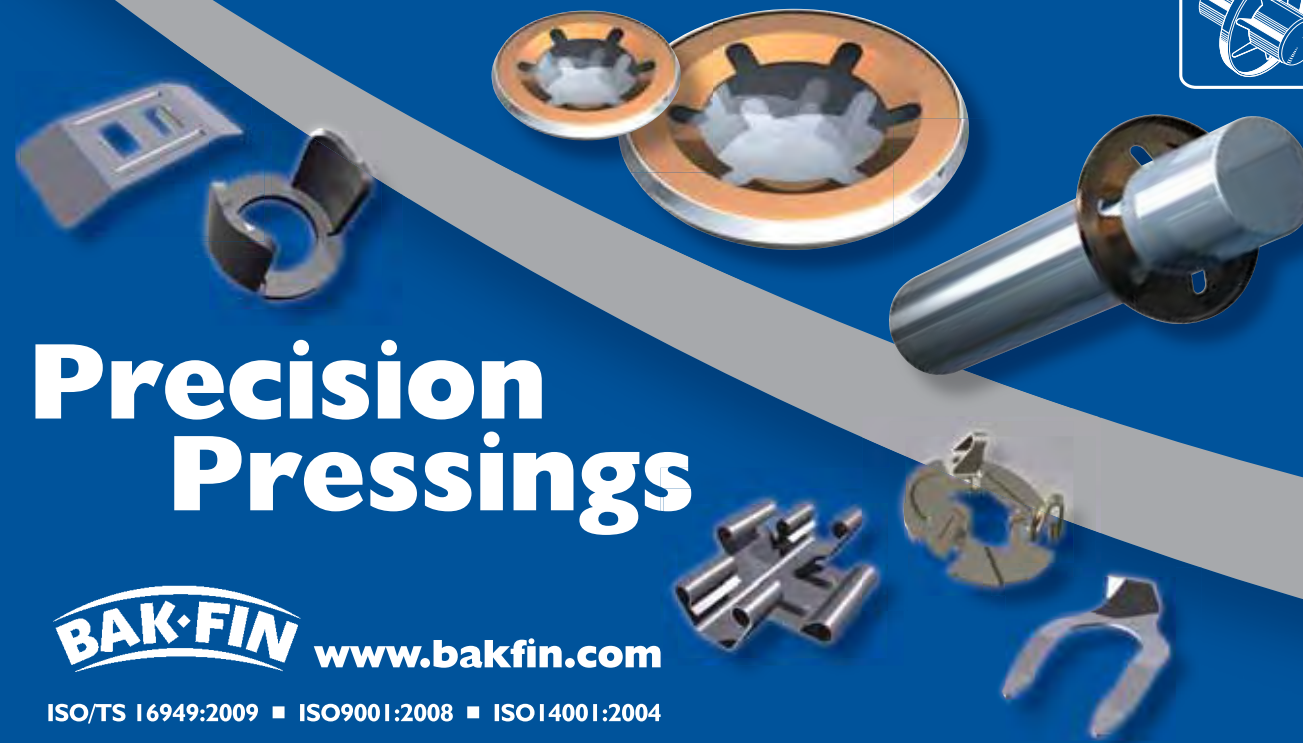

Precision Pressings

www.bakfin.com

ISO/TS 16949:2009 ■ ISO9001:2008 ■ ISO14001:2004

Baker & Finmore Limited, 199 Newhall Street, Birmingham, B3 1SN, UK Tel: +44 (0) 121 236 2347 Fax: +44 (0) 121 236 7224 e-mail: sales@bakfin.com



4 for all your fastener requirements...



3 here are just of our unique fastener solutions...



2 answer all your fastener questions...



1 go to the No. 1 supplier for all fasteners!

- Barb Nuts • Carp Nuts • SEMS Screws •
- Staytap Screws • Hi-Lo Screws • BT Screws •
- Staytite Nuts • Stover Nuts • Hardlock Nuts •
- Flange Nuts & Bolts • Serrated Flange Nuts •
- Serrated Flange Bolts •



Hardlock Nut - the proven solution in threaded joints



FASTCASE STUDY

Thread lockers deliver the highest safety standards

Despite their origins in fifteenth century Russia, Rollercoasters are now the stuff of adrenalin junkies worldwide and have come a long way in engineering terms since their medieval beginnings. The latest generation of these machines have taken performance to another level, creating forces that demand the highest standards of engineering and maintenance. And it is for this reason that one of a new breed of hypercoasters relies on Loctite engineering adhesives for its threadlocking and retaining needs.

One such monster, the Silver Star is a super-tuned 1,620m long, 73m high hypercoaster that travels at speeds of up to 130km/h. Its performance equals the acceleration and G-force of a Formula One car but without an engine. The speed and passenger load are constantly calculated to



Retaining the ball bearing casing with Loctite 638

apply just the right amount of magnetic braking but vibration needs to be kept to an absolute minimum and this is where Loctite comes in.

The safety bars that hold passengers in their seats are checked every day and annually stripped



Silver Star rollercoaster ride ensures safety with modern adhesives

down completely for detailed inspection. When re-assembling, the maintenance engineers use Loctite 243 to threadlock the bolts that connect the ratchet components to the main bar. This product is part of a range of threadlocking adhesives that prevent self-loosening and secure any threaded fastener against vibration or shock loads. It fills the gaps between mating threads and eliminates fretting corrosion by creating a unitised assembly.

The chief engineer in charge of Silver Star maintenance, Hans Volz explained: "Because Loctite 243 is medium strength, it is strong enough to withstand the loads and vibrations but can be disassembled for maintenance. It is perfect for us."

Rolling stock

Guide wheels are crucial to providing a fast but safe ride and keep the train locked to the track from above, below and from the side. And like the safety bars, the wheel units are checked daily and subject to thorough inspection

and re-assembly annually. The steel ball-bearing cages must be completely removed from the aluminium wheels during this process.

Because aluminium expands faster than steel, engineers warm the wheels to 70°C which allows them to simply push out the steel

ball bearing cage. They then clean all surfaces with Loctite 7063. This is a general purpose cleaner and degreaser that leaves no residue and is ideal for use prior to adhesive bonding and sealing applications.

Loctite 638 is then applied to re-fix the cage. Widely used to secure bearings, bushes and cylindrical parts, this high strength retaining compound has been formulated to provide the best resistance to dynamic, axial and radial loads. It achieves maximum load transmission capability, uniform stress distribution and also eliminates fretting corrosion.

The bolts that secure the ball-bearing cage casings and those that fasten the wheels to the train are then threadlocked with Loctite 243. "This product saves us a lot of time but does not compromise reliability in any way," concluded engineer Achim Stoss. "It holds tight for as long as we need it to but we can still dismantle parts with hand tools."

HENKEL LOCTITE ADHESIVES
01442 278100



The all-important safety bars are secured with a threadlocker after maintenance inspections

Q & A

Can motorsport lead latch design?

Peter Boote fields the frequently asked questions he receives about Aerocatch, a shear pin latch with its origins in motorsport



Peter Boote is managing director of Specialty Fasteners & Components and has over 35 years' experience (he started at a very young age) in special fasteners and hardware for the aerospace, defence, industrial and motorsport markets. He started with ISC Fasteners, the agents for Rosan fasteners and then moved to Camloc on the acquisition of Rosan by Rexnord who were Camloc's parent company.

Boote started Specialty Fasteners in 1994 which has developed into a design, manufacture and distribution company with its own product ranges such as the AeroCatch whilst working closely with its principals such as Camloc, Hydraflow, Stop-Choc, Accuride and Camloc Gas Springs to over a complete package of specialised and standard fasteners and hardware.

We've heard of AeroCatch but are unsure exactly what it is. Can you enlighten us?

AeroCatch is a family of fasteners originally designed for motorsport applications but now finding applications in the wider industrial and defence sectors. The original AeroCatch is a shear pin latch for panel on panel applications with an adjustable strike pin to allow for any variation in fit. AeroCatch2 evolved after a request from an offshore powerboat team for a shoot bolt style latch for use on fixing engine covers and hatches. AeroCatch 3 is a shear and tension latch comprising of two symmetrical halves, the latch and strike, which are pulled together by a draw hook with the added feature of a shear tongue which engages the latch to the strike making it the ideal solution for large area panels as found on Le Mans style race cars.

Who makes AeroCatch and where?

Totnes, South Devon based Specialty Fasteners & Components designs and manufactures AeroCatch. All tooling and the vast majority of components are all sourced within the South West with final assembly at the Totnes facility.

So you designed it yourselves in Totnes, had it prototyped locally and it's made here in the UK. Surely there are enough alternatives to 'normal' bonnet-pins already on the market?

We have always supplied quick release fasteners to the motorsport market and we started to receive requests from manufacturers wanting a latching system that fitted with the styling and aerodynamics of their design rather than the existing, somewhat agricultural looking latch which often looked as if it had fitted as an afterthought. Our research prior to starting the design process highlighted the fact that just about every competition car used a similar style of fixing for bonnets, boots and tailgates with very few alternatives available. This was nothing more complicated than a simple sliding lynch pin surface mounted which performed satisfactorily but is unsightly and unsuitable for road use.

AeroCatch was designed to fasten the bonnet or panel down but with all the locking mechanism below the surface of the panel giving improved styling and enabling the part to meet road worthiness conditions. Along with the improvements to the aesthetics of the part we were able to add a secondary lock feature for additional functional security and the option of key locking for security when the vehicle is parked. During the design process we incorporated side entry for the AeroCatch enabling it to be used for slide fit applications such as bodywork sections therefore opening up more potential application areas, this is something that cannot be done with conventional bonnet pins.



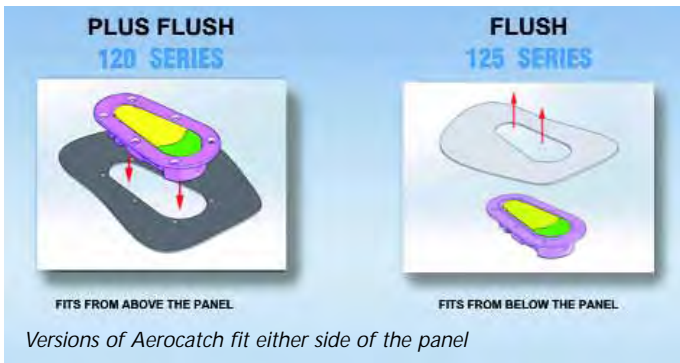

When we started the design process we did not have 3D CAD facilities in house so worked with Exeter University to develop rapid prototype models to get feedback from potential customers. Several variations of the design were made and with customer input we evolved the AeroCatch into the form you see today.

Does AeroCatch provide users with any evidence of it being positively locked?

Yes, to lock an AeroCatch is a two stage operation. The first stage engages the slide pin into the strike leaving the handle in its free travel state. At this point the AeroCatch is secure but further pressure on the handle engages the secondary lock button. AeroCatch is now completely secure. A safety feature of the AeroCatch is that the handle is highly visible when in the open position thereby reducing the risk of the bonnet not being securely fastened, an experience many had previously experienced with the traditional arrangement

In motorsport applications, is AeroCatch any safer than 'standard' bonnet pins?

A traditional type bonnet pin relies on a spring loaded snap ring to lock the pin in place, this can either not be engaged when the bonnet is closed or knocked open resulting in the pins disengaging under vibration and the bonnet opening. The AeroCatch, on the other hand, has a secondary lock feature with the handle highly visible when in the open position providing an easy check as to whether the bonnet is securely fastened. The optional key locking feature has been well received by as a means of added security when cars are left unattended.

AeroCatch is not only used on completion cars and it's pedestrian friendly and road legal design with no sharp parts protruding through the panel combined with its styling has been an important feature in it becoming widely accepted for the road tuning market.

How important is styling?

Many of the fastener products we supply are never seen as they are buried deep inside assemblies but the AeroCatch is different in that it is highly visible so it was important that we made it look as aerodynamic and aesthetically pleasing as possible. We worked around the footprint of the traditional bonnet pin and by dropping the mechanism below the bonnet line were able to have either a completely flush design, which requires a little more care in panel preparation, or the plus flush version which is considered easier to fit. The composite material it is made from is to an automotive standard and can be painted to match the car's bodywork if required. We have also added a carbon-look and white versions to give customers more choice.

What would you say are the most important AeroCatch selling points?

AeroCatch appeals to a wide variety of users because of its modern aerodynamic styling, security, lightweight and performance and is now seen used by major completion and road tuning marques. Customers also like the fact that AeroCatch is supplied in packs of two with a fitting template and all the parts required to fit it. Available around the world through a network of dealers who support the product with stock and local promotions AeroCatch is becoming a truly global brand and the panel fastener of choice.

SPECIALTY FASTENERS 01803 868677

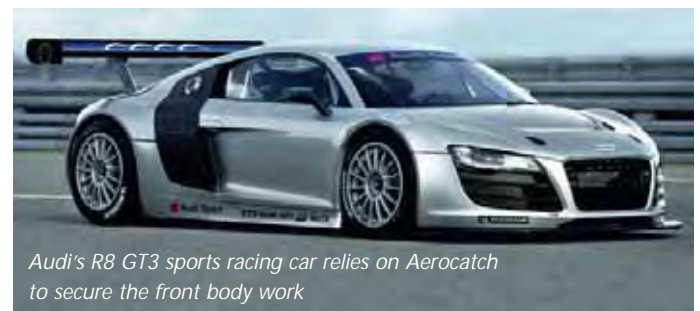

Huck BobTail Fastening System®

The Next Step in LockBolt Evolution...





- A permanent, mechanically locked fastener
- Unlike conventional nuts and bolts, they will not work loose, even during extreme vibration
- Pintail-less design eliminates material waste, reduces installation noise & improves corrosion resistance

🇬🇧 0800 019 8180 info@afshuck.net www.afshuck.net



Alcoa
Fastening
Systems



PRECISION DISPENSING

The endless piston pump

An ideal process involving the application of fluids and liquids would have a pre-determined volume of material applied to a location with accuracy and consistency. This may have more importance in fields like medical device manufacturing or microelectronics but all engineers want to remove variability in their processes. Peter Swanson reports

For over 30 years, the dispensing of industrial fluids has been improved by simple time/pressure dispensing machines or controllers. A syringe like barrel with the liquid inside is attached to the dispensing controller, which pushes compressed air into the larger end when needed. This compressed air can be a timed pulse and pushes the liquid out of the smaller end of the syringe barrel, usually through a dispensing needle or nozzle.

of about 0.25mm, quite small dots can be dispensed. Limitations of this approach include having to have the liquid packed in a dispensing syringe barrel. Many materials are available from manufacturers packaged appropriately or they can be filled subsequently by a third party service. Any air inclusion in the barrel will affect deposit accuracy, so the filling process (which may include centrifuging) is a factor.

allow the material flow to be started/stopped or otherwise controlled. A fully automated fluid application operation often uses a dispensing valve, as it precludes the need for the exchange of empty barrels for filled ones, for example. The quest for a true, volumetric dispense has led to the development of valves which work on a positive displacement principle. Within the valve, a cavity of the desired volume is filled with the liquid, and then this volume is ejected mechanically or pneumatically. For example, this can be achieved with a tube which is pinched by pistons at either end to form a cylinder of the appropriate volume. The sequence of opening and closing the pistons will dispense that volume. Another method is to use an auger screw inside a tube which can be driven by a motor. These valves are usually specific to a limited range of deposit size or to certain viscosities.

Recently, a pump technology which delivers positive displacement, volumetric dispensing or dosing has been applied to the precision application of industrial materials, and which can deliver as little as 0.1 μl . A progressive cavity pump is a type of positive displacement pump.



A time/pressure dispensing controller with a digital timer

One variable which is difficult to control is material viscosity; the less viscous the fluid is, the greater is its ease of movement and the larger the dispensed amount will be for the same settings. Viscosity can change with ambient temperature or with repeated quick air pulses. The material may also change due to curing; such is the case with a mixed epoxy adhesive, for example.

Another issue is the variability in dispensed quantity as the syringe barrel empties. The amount of compressible air in the system increases according-

The amount dispensed is dependent on: the rheology of the liquid (viscosity and thixotropy); the air pressure; the time of the pulse of air; and the size of the orifice in the needle. The latter three factors are selectable and with the choice of a suitable combination of these most flowable liquids can be dispensed in beads or drops with a reasonable amount of accuracy and repeatability. Many thousands of these machines have been sold, with major benefits to users, including material control and health and safety.

Typically, these devices are used manually or in a semi-automated process. Employing low viscosity liquids and the finest needle size, with an inside diameter

ly, which means that the same pulse of compressed air from the dispensing controller has a lesser, delayed impact on the liquid, resulting in smaller deposits.

Some of the limitations of simple time and pressure dispensing can be mitigated by the use of dispensing valves. These are typically pneumatically controlled valves into which the material is fed (usually under pressure from a reservoir) and which



Endless-Piston-Principle technology in a pen, with digital controller

Peter Swanson, MA (Cantab) is managing director of Intertronics

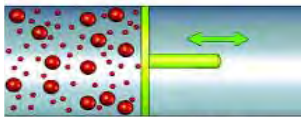

If you imagine a piston...

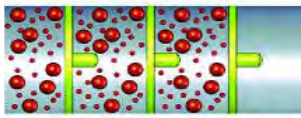

...or better, several pistons in succession...

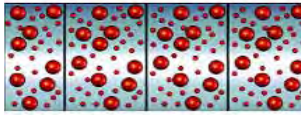

...make the wall thickness of the piston zero...

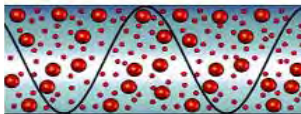

...slightly change the piston shape...

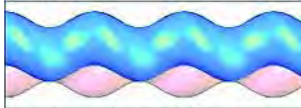

...now you've got the endless-piston-principle...

Typically, it consists of a single helix metal rotor and a double helix hole in an elastomeric stator. The rotor seals against the stator, forming a series of spaces or pockets, which translate along as the rotor rotates, keeping their form and volume. The pumped material is moved inside the pockets. In addition, the pockets are shaped such that they taper and overlap; the output is continuous, even and non-pulsing.

The flow rate is directly proportional to the rate of rotation and the volumetric output of the pump is directly proportional to the number of rotations. Due to the rotor/stator seal, input pressure has no effect on the pump, so it achieves true positive displacement. It is also able to pump at very low rates, and low levels of shear are applied to the pumped fluid.

Dispensing or dosing units based on this technology are available for precision applications. They consist of the rotor/stator assembly and a motor drive unit, in a pen-like configuration. A separate controller allows programming of the motor speed and number of rotations to effect dots or deposits of specific volumes, or continuous beads. When the dispensing operation is complete, the motor can be reversed

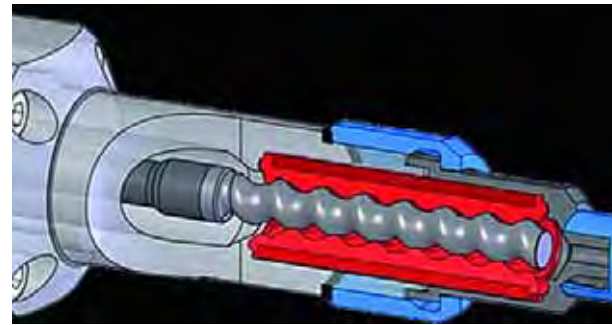

The rotor/stator assembly in a pen configuration

briefly to prevent stringing or dripping. A dispensing needle is fitted to the end of the pen using a standard luer fitting. Crucially, once a material has been characterised, a desired volume can be selected on the controller, which is dispensed regardless of material viscosity changes and independent of ambient temperature. The technology handles viscosities from water up to very high viscosity pastes, including abrasive, filled or shear-sensitive media. Flow rates range from around 0.1 to 60 ml/minute and the pen can be hand-held or fitted to automation.

INTERTRONICS
01865 842842

HIGH PERFORMANCE ADHESIVE TECHNOLOGY



- 1 & 2 Part Structural Adhesives
- UV Curing Adhesives
- Conductive Adhesives
- Instant Adhesives
- Ultra High Temperature Adhesives
- High Performance Adhesive Tapes



Bonham Drive, Eurolink Industrial Estate,
Sittingbourne, Kent ME10 3RY

www.eurobond-adhesives.co.uk
sales@eurobond-adhesives.co.uk

T 01795 427888

Eurobond
ADHESIVES LIMITED

bigHead®

Secure fasteners for Composites

Embedded or surface bonded, bigHead fasteners save time.



Visit our website:

www.bighead.co.uk

+44 (0)1202 574 601



INGENIOUS. INNOVATIVE. IN-STOCK.

With over 19,000 stock springs, extensive custom capabilities and over 90 years of expertise, Lee Spring continues to respond to yesterday's needs, today's demands and tomorrow's technology. We lead the industry with innovative products like LeeP™ Plastic Composite Springs, BANTAM™ Mini Springs and Lite Pressure™ Springs.

Whether you need 10 springs or 10 million springs, our World-Class Service and comprehensive website make finding the right spring easy. Call or email us today to learn more.

Tel: +44 (0)118 978 1800

Web: www.leepring.com
www.leepring.co.uk

Email: sales@leepring.co.uk



"Panel Fittings For Every Enclosure"
FDB PANEL FITTINGS
Quality Products - Quality Service



Call Us: 020 8568 1616

or

Visit: www.fdb.co.uk Email: info@fdb.co.uk

HI-GRIP®



HIGH PERFORMANCE HOSE CLIPS TO BS5315

HI-GRIP

- MILD STEEL BRIGHT ZINC PLATED & PASSIVATED
- THE HIGHEST QUALITY CLIP AVAILABLE TODAY
- ROUND EDGE BAND FOR BEST HOSE PROTECTION

HI-GRIP STAINLESS

- ALL PARTS MADE FROM 18/8 STAINLESS STEEL
- LLOYD'S REGISTER TYPE APPROVAL
- FIRST CHOICE FOR THE MARINE INDUSTRY

HI-GRIP WING SCREW ZINC PLATED AND STAINLESS STEEL RANGES

- IDEAL FOR FREQUENTLY REMOVED HOSES IN
 - LABORATORY
 - INDUSTRY
 - GARDEN
 - HOME
- SUPER FREE RUNNING & EXCELLENT SEALING

HI-GRIP FLEXIBLE SCREWDRIVER

- MAKES FITTING EASIER IN AWKWARD PLACES
- WILL NOT SLIP OFF SCREWHEAD

JCS

HI-TORQUE LTD

CHILTON INDUSTRIAL ESTATE SUDBURY
SUFFOLK • CO10 2YH • ENGLAND

TEL (DIRECT SALES) +44 (0) 1787 888031
TEL (SWITCHBOARD) +44 (0) 1787 376212
FAX +44 (0) 1787 880633

E-MAIL: sales@jshi-torque.co.uk
WEBSITE: www.jshi-torque.co.uk



Coping with the heat

Because the legal requirement to cut diesel emissions has led to higher operating temperatures, the engine OEMs have had to develop new materials and redesign the fasteners used in these hotter components

Diesel engine emission standards have been regulated for over 15 years. Since the implementation of Tier 1 diesel engine emission regulations in 1996, the EPA signed the final rule introducing Tier 4 standards which require a reduction in tailpipe emissions by about 90%, to be phased-in by 2015. This affects engines used in farm tractors, excavators, bulldozers, wheel loaders, backhoe loaders, road graders, diesel lawn tractors, logging equipment, portable generators, skid steer loaders, forklifts and similar equipment.

How can such a substantial reduction in emissions be achieved? Among the different ways to increase efficiency of a combustible engine, increasing exhaust temperatures to burn off more excess soot and particulates is one frequently used approach.

By raising diesel engine operating and exhaust temperatures, almost every component in the engine compartment will absorb more heat than originally intended in past designs. Naturally, much research and development has gone into re-engineering engine components to meet these elevated temperatures.

One family of components - that is often one of the last items to be consid-

ered in engine designs or upgrades - is fasteners. bolts, screws, and nuts that hold together turbo chargers, manifolds, and fuel systems are critical to engine performance and reliability. An example of an application in which fasteners are tasked with the impossible is the turbo charger mounting to the exhaust manifold. In most cases, four studs and nuts are used to hold the two components together. The problem is that the size of the fasteners has not changed from the original design where turbo chargers only weighed approximately 35 lbs. Now turbo chargers weigh in at well over 75lbs. While this is only one instance, other areas of the engine, fuel pumping systems and exhaust manifold segments face the same issues.

To combat the high temperature yielding of fasteners, engine OEMs have upgraded fastener materials over the years, evolving from high strength carbon steel used in the past to austenitic and martensitic stainless steels, to finally utilise high alloy materials such as A286, inconel or waspaloy. Diesel engines now use some of the same materials that are used in aircraft jet engines.

Fastener material yielding tempera-

tures, however, are only one of the elements considered in engine design to ensure optimal performance and reliability. Fastener loosening under heavy vibration is another. Most fastener locking devices, particularly adhesives or plastic patches used with standard 60° thread, rely on elements such as plastics or anaerobic adhesives that are not able to stand up to high temperatures. Other solutions include interference types of threads which are not reusable and tend to seize in high alloy materials during tightening.

Uniquely designed Spiralock self-locking internal thread form, available in high alloy materials, successfully addresses both the high heat and vibration problems. The Spiralock design features a 30° wedge ramp at the root of the thread. The wedge ramp allows the bolt to spin freely relative to the female threads until clamp load is applied. At that point, the crests of the standard male thread form are drawn tightly against the wedge ramp, eliminating radial clearances and creating a continuous spiral line contact along the entire length of the thread engagement. This continuous line contact spreads the clamp force more evenly over all the engaged threads, improving joint fatigue life as well as the integrity of the threaded joint. Spiralock fasteners are reusable and provide a significant reduction of galling during assembly.

Numerous dynamometer tests have been performed to confirm Spiralock's superior performance as the ideal fastener for the current and future demands of diesel engines. Major OEMs adopt Spiralock fastening solutions throughout engine assemblies. Typical Spiralock applications include turbo mounts and housing brackets, EGR cooler heat shield mounts, fuel pump mounting systems, exhaust manifold mounts, turbocharger actuators, turbo V-band clamps and engine coil assembly.

SPIRALOCK
01604 827216

Combating high temperature yielding in turbochargers has forced OEMs to upgrade fastener materials



AUTOMOTIVE DESIGN

Designing a quieter and more economical ride

The drive for more fuel efficient vehicles which retain a good level of performance has led to dramatic reductions in panel weight and a rethink of fastening techniques

After the roller coaster ride of 2011, industry experts forecasted an upward shift in gears for the global auto industry. In the main, this is down to the famous new-car smell tempting recession-weary buyers to finally taking the plunge and trade in their rambling wrecks, enticed by the latest technology and more freely flowing credit.

Despite ongoing economic uncertainties in the Eurozone, EU motor manufacturing is expected to be a key industry to follow in 2012 with a forecast of 14 million car sales predicted for the year. With regards to new car design, sustainability continues to a driving force behind this industry growth. However, to the car buyer who is searching for the best performing, yet most fuel-efficient vehicle, the areas of a vehicle where the greatest efficiency gains can be made may not always be that obvious.

According to auto access hardware and positioning control specialist, Southco, there is a continuing requirement in the design of new cars and trucks for the attachment of lightweight underbody protective shields. These improve both aerodynamic efficiency beneath the vehicle and overall fuel economy by decreasing drag. Further benefits are to be gained from reduced road and engine noise being transmitted into passenger compartments



Southco's D4 Dzus standard line quarter-turn system provides for a high clamp force and strength, and is vibration resistant

– already a legislative requirement in many parts of the world - together with underbody component protection from road impact, debris, and ingress and accumulation of dirt and water spray into the engine compartment. More cars and more underbody protective shields are good news for companies within the automotive OEM supply chain, as this increases the demand for associated components, such as robust fastening mechanisms. These fasteners must allow both rapid and easy installation on the assembly line, yet also enable subsequent fast access for post-assembly servicing.

Southco claims to lead the way in tackling the access demands of the growing automotive sector with its market-leading range of Dzus quarter-turn fasteners.

Southco is a leading global provider of engineered access solutions, including latches, locks, captive fasteners, hinges, handles, and other accessories for applications in the marine, networking, telecommunications, computer, automotive, aerospace, mass transit, off-highway/construction, RV/caravan, industrial machinery and HVAC industries.

Southco is strongly focused on customised engineering solutions and global support for its key customers. The company aspires to be a virtual engineering center for its customers' engineered-access solutions and is committed to providing outstanding quality and overall satisfaction. Southco's promise to its customers is to connect, create and innovate to provide the best solution for every access engineering problem.

Dzus, the pioneer of quick-access fasteners with a history going back to the 1930s, was acquired by Southco in 2004 and the two brands have been harmonised, enhanced and developed over the past eight years. The company has the global resources and ability to offer automotive OEMs worldwide a superior and effective replacement to conventional threaded fastening devices which exactly satisfy

their demands for quick-access fasteners to meet the underbody and protective shield requirements of today's cars and trucks.

The key benefits of Dzus quarter-turn fasteners include resistance to vibration, fatigue and temperature changes, resistance to corrosion, and the choice of a variety of head style options. Furthermore, thanks to advanced technology developed by working closely with automotive customers over many years, the Dzus fasteners can be simply secured to steel, aluminium or composite chassis underbody components through pre-punched holes.

Ulrike Sturman, industry marketing manager for transportation at Southco, explained: "There is a perpetual contrast between fasteners based on traditional screw thread systems and those based on quick-release mechanisms. It has long been perceived that, for a robust and durable fastening system, threaded fasteners offer the most cost-effective solution."

Although a threaded system might be cheap to buy, the time it takes to lock and unlock the system makes it expensive in terms of initial installation. "The recovery gains of the Dzus quick access quarter-



A mix of styles in the D8 quarter-turn fastener can accommodate a total material thickness from 0.7mm to 32.4mm

turn system, made from reducing the time it takes to install and then from future access needed for servicing more than outweighs the upfront investment,” Sturman added. “Also, the Dzus quarter-turn stud is retained in the panel and will not get lost during maintenance work.”

More recently, the company has developed a range of new quarter-turns and accessories. These include a stud that has an orientated head feature to cam. This brings the added benefits of the head feature always engaging and locking in the same position. The lock position of panel fasteners can therefore be identified, and

installation time is speeded up. Furthermore, in response to the increased use of textile-type panels in the auto industry, Southco offers larger washer faced quarter turns which spread the load and therefore provide for a stronger and more robust fastening system.

Sturman summarised: “At Southco, we are looking closely at the market potential resulting from the increased demand for new cars and 4x4s and we also recognize the significant opportunities presented by the growing electric car market, where our fasteners are ideal for securing, and providing quick access to, battery pack enclosures.”

The company offers an extensive range of Dzus fasteners which satisfy individual requirements and applications across a wide range of industries for quick access, high strength and economic performance. Each product line comes with its own set of matched receptacles for accurate, secure engagement and convenient mounting in a range of applications.

SOUTHCO EUROPE
01905 346500



The D8 fastener is available in various sizes and head styles offer flexibility in mounting configurations and applications



**LOW CARBON
FASTENER
TECHNOLOGY**

PROFIL – LESS IS GOOD



Reduce your manufacturing carbon footprint today, save energy, time and money. Specify Profil.

Profil UK, Unit 6 Whitwick Business Centre, Stenson Road, Coalville, Leicestershire LE67 4JP
Tel: 01530 276515 Fax: 01530 276516 www.profil.eu



Fully automatic placement



Robotic controlled placement



Inlex Locking Ltd

THREAD LOCKING & SEALING



www.anochrome.co.uk



INLEX LOCKING LTD
Wood lane Fordhouses Wolverhampton WV10 8HN
Tel. 01902 397300 Fax. 01922 785372
Email: enquiries@anochrome-group.co.uk

STOLEN



There's no need to
'liberate' someone
else's FAST Magazine.
Ask for your own free
copy to be delivered!

Register at
www.fastmagazine.co.uk

Or

Call our reader registration team
on 0845 602 7390

FAST

FASTENING & ASSEMBLY SOLUTIONS AND TECHNOLOGY

precision engineering continuous hinges

- Range of sizes, light, medium & heavy duty
- For Engineering, architectural & furniture
- Attractive and practical
- Excellent load carrying capacity
- ISO accredited & special options available
- A range of materials & finishes



P H O E N I X

COOKE BROTHERS

master hinge makers

01922 740011

cookebrothers.co.uk

sales@cookebrothers.co.uk



A secret fixing for decorative panels

An ingenious panel fastener has been developed by a London-based engineering designer. Paul Gay visited Wills Watson Associates' showroom to see how it works

Quay Shopfitters has a slogan on its website that states: 'Our experience in fitting and running restaurants means we know what works'. So before Quay's joiners could be persuaded to change their concealed fixings, they needed some firm proof that the new fasteners would do the job.



Durable nylon buttons are attached to one panel and the mating fixes to the other

Using a set of free samples, Quay made up a test panel which was presented to the client for approval by the design director. But testing it on a real project would earn the real seal of approval and that is exactly what they did.

Mike Cookson, contracts manager at Quay Shopfitters: "We have just completed [our] first project using Button Fix products. The client – a takeaway in Felling, Gateshead called Pizza Euro – wanted a modern approach, using flush fitted HD digital poster frames to display menus and special offers. We used button-

fix to secure all the panels in the shop, giving quick installation, secure and hidden fixings."

The button-fix concept was developed by designers Wills Watson Associates in the City of London.

The concept is really very simple: durable nylon buttons are attached to one panel and the mating fixes are attached to the other. To secure the joint, the panels are brought together until the button-fixes click.

Two types of button-fix have been developed: the Type 1 Fix is either surface-mounted or rebated into the panel, and orientated for vertical or sideways assembly. The Type 2 connects panels which are intended to be perpendicular to each other.

The Type 1 Fix is surface-mounted or rebated into the panel, and orientated for vertical or sideways assembly, requiring a 15mm clearance to engage. The fastener is Ideal for applications where strength and security are paramount. Tests have shown that the product will only fail when bolted to the panel and holding a load of 298kg. Normally the product is screwed to the panels being joined and will not fail before the screws pull out of their sockets.

There is a button marker accessory which helps to mark out where to install the components. Once the fix mouldings have been attached, the fitter snaps a marker into each one. The removable panel is then positioned and pressed firmly so that the markers leave indents in the panel surface, which can be used as guides for drilling pilot holes for the buttons. The markers can then be removed and re-used for the next panel.

The Type 2 Fix, which is being launched at the forthcoming FAST Exhibition later this

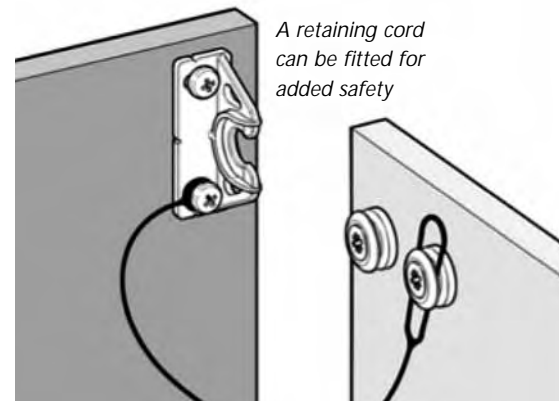

A retaining cord can be fitted for added safety

month, connects panels at 90°, allowing for direct push/pull access. This new addition lets the designer use button-fix in even more applications and makes it ideal where the emphasis is on ease of fit rather than strength with a simple push/pull assembly. The buttons are the same as with the Type 1 fix and so connect with the fix with a click.

Setting out the fixes will depend on whether the panels overfly or are mounted within the background structure. The choice depends on specific need but using Type 2 makes installation quick and easy with either option. And if added safety is essential to the fit then there is a safety cord accessory specifically for use with Type 2 to stop the panels from falling.

Another interesting use of button-fix is at Heathrow's Terminal 5. Contractors were obliged to fit retractable doors on the cubicle in public lavatories at the airport. UK building regulations demand that doors open from the outside so that if a person becomes ill and collapses against the inside of the door, release is possible by removing a panel which covers the locking mechanism. The panel can be fitted flush to the door and its frame using concealed fixings such as button-fix.

SDS London has been appointed as a distributor and now stocks the full range of button-fix and its associated accessories.

BUTTON-FIX 020 8150 7190

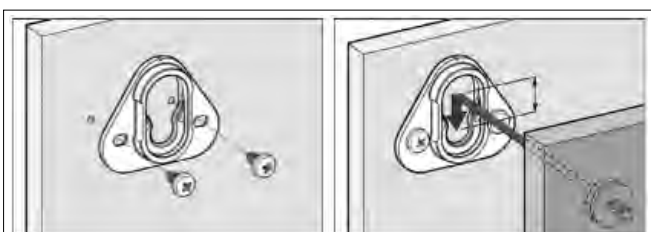

The panels are brought together until the button-fixes click

CLINCH YOUR PROJECT WITH TOG-L-LOC®

BTM'S patented sheet joining system joins plain AND coated metals with consistent, strong, leak proof joints

Tog-L-Loc® provides omni-directional strength and is widely used in the assembly of Automotive, White Goods, H.V.A.C and many other sheet metal products. Choose from a variety of tool options for applying Tog-L-Loc® to suit your specific manufacturing requirements.

Below are typical examples of how Tog-L-Loc® can also save on the cost of consumables such as rivets, nuts & bolts, weld tips and adhesives.



BTM Robot Cell



Duct Joining Clinch Gun

- ✓ **Lit-L-Loc® Hand Gun** with Hydraulic Intensifier
An inexpensive tool for low volume production. Capable of joining a maximum thickness of 3.0mm mild steel.
Various strokes & throat depths available.
- ✓ **BTM Small Production Presses** - either pneumatic, hydraulic or pneumohydraulic systems can be designed and built to your specifications.
Single or multiple joints not a problem!
- ✓ **BTM Robot Cells** - either single cell or multiple cells for medium to high volume production.
Any Robot any size!
- ✓ **BTM Single Joint Presses** - these can be floor standing or bench mounted utilising either BTM's patented pneumatic toggle head, hydraulic system or the very economical pneumohydraulic system.
Operated via foot switch or two-hand start safety system (depending on stroke of press)
Standard Units from 10kN to 400kN
Various strokes & throat depths available.
- ✓ **BTM Press Brake Tooling** is an effective & cost saving way to utilize our patented Tog-L-Loc® sheet metal joining system and are available with a wide range of throat depths.
Use a single unit or stack them up for multiple joint applications.
Ready to install in your power press!
- ✓ **BTM Duct Joining Clinch Gun** - pivoting jaws allow the operator to manually open the jaws to allow clearance of flanges etc.
Several sizes and styles available.



BTM (UK) Automation Products Ltd
Tel: 01767 677001
Email: btmautomation@btconnect.com
Web: www.clinching.co.uk

SOUTHCO® E3 Compression latches



Designed for quick, secure closure in applications where vibration, sealing, and quality are paramount

Over 5000 **INDUSTRY PROVEN** variations including multiple sizes, materials and access styles

POSITION IT ACCESS IT FASTEN IT SECURE IT ADJUST IT

www.southco.com/E32 - info@southco.com

Europe Customer and Technical Support Centre

Tel: (44) (0) 1905 346722 - Fax: (44) (0) 1905 34672

southco®
CONNECT · CREATE · INNOVATE

Blowing in the wind

The sails to be installed in a 50KW vertical axis off shore wind energy turbine prototype have been adhesive bonded to retain the strength and low weight of the composite structure. The scaled up production units will have to remain in service for 20 years without maintenance

A key milestone has been achieved for the UK Nova project team with the successful construction of the sails for a fully working 50KW prototype demonstrator of their new concept 10 MW off shore double arm vertical axis wind turbine system (VAWTS). Nova is a two year renewable energy feasibility project, supported by the UK Energy Technologies Institute (ETI) and the Engineering and Science Research Council (EPSRC), with financial support from the European Regional Development Fund (ERDF). The project aims to investigate the affordability and feasibility of manufacturing a VAWTS of this design and scale. The NOVA project

tural bonding of the various carbon fibre and glass fibre epoxy composite parts which make up the two 10 metre by 1.9 metre rotor sails. To be a viable, the planned massive scale up in off shore wind turbine manufacture will require the rotor blades to sustain at least 20 years' service without maintenance. As such, the structural design and selection of suitable high quality materials with these long term performance capabilities is a critical success factor for this project.

Scaled down prototype demonstrator By first developing a 50KW prototype scaled down demonstrator with embedded structural strain and air pressure monitoring, the Nova Project team will be able to gain an understanding of the engineering performance and aerodynamic behaviour of the design in use and extensively test in off shore operational conditions the composite materials selected.

The fabrication stage has already helped them to address on a much smaller scale, any processing challenges to cost effectively manufacture and assemble the

composite components; these can then be applied to the full sized version to help ensure its affordability and commercial viability. This novel vertical axis turbine design aims to become a fully commercialised 10MW offshore wind turbine, which will have two 160 metre length arms supporting two 80 metre long V-shaped sails; when built, it would be the heaviest composite construction in the world, weighing around 160 tonne.

The overall wind turbine assembly has

been designed and constructed to have the best structural reliability long term in order to meet the key criteria of being maintenance free during its expected 20 years service period. The two prototype rotor sails each have dimensions of 10 metre long by 1.9 metre wide, with a maximum depth of 180mm at the mid section. The structural approach used for the rotor sails is similar to a large commercial aircraft wing. The sail has a cen-

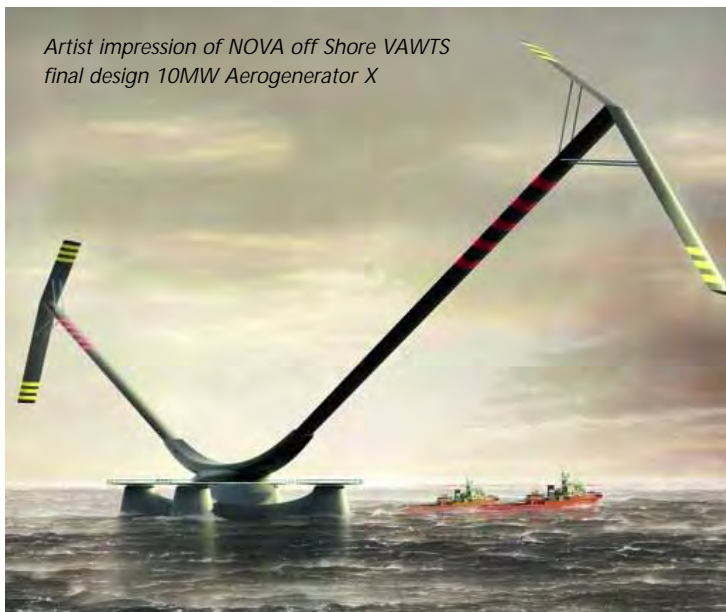

50KW VAWTS demonstrator will be located on the Cranfield campus and be operational from October 2012.

The 50KW prototype was manufactured at Cranfield University's Composites Centre, with extensive advice and support in the design and manufacturing provided by key material suppliers. This included Scott Bader Company, whose Crystic Crestomer 1152PA urethane acrylate structural adhesive has been specified for the light weight struc-

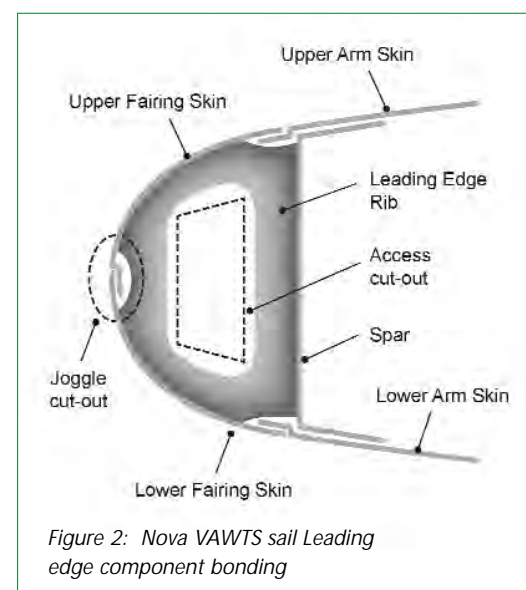
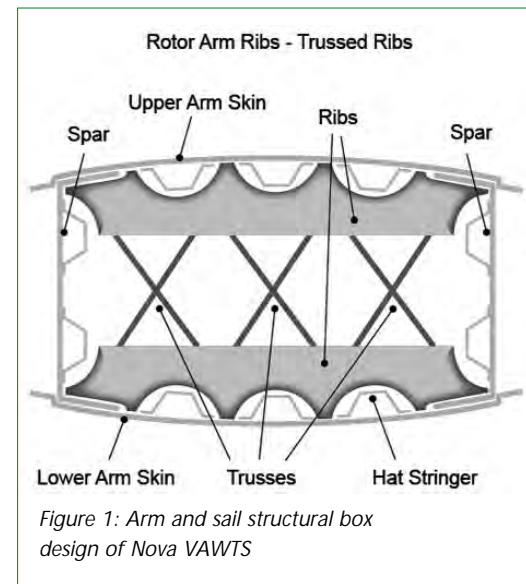

Your global trusted partner in **bolt optimization**



The Nord-Lock Group is a world leader in bolt securing systems. We offer a unique combination of bolting expertise and a wide product range, including wedge-locking solutions and Superbolt tensioners.

Our mission is to safeguard human lives and customer investments by securing the world's most demanding applications.



NORD-LOCK
Bolt securing systems



Nord-Lock Ltd • Tel +44 (0)198 084 7129 • Fax +44 (0)198 084 7674
enquiries@nord-lock.co.uk • www.nord-lock.com

**ADHESIVES
SEALANTS
DISPENSING
CURING
ENCAPSULATION
MASKING
ROBOTICS**

www.adhesive.uk.com

01865 842842
sales@intertronics.co.uk

adhereTM
better bonding from intertronics



What ever the structural bonding application problem..



there is an Epoxy,
Polyurethane or
Methacrylate Solution!

Axson
TECHNOLOGIES

For more information contact:

Axson UK Ltd, Unit 15 Studlands Park Industrial Estate
Newmarket Suffolk CB8 7AU
Tel: 01638 660052 Fax: 01638 665078
Website: <http://www.axson.com>

tral box section, designed with tapering thickness skins, two C spars with ribs and omega shaped hat stringers to provide resistance to buckling (figure 1). The sail central box components were manufactured from multi-directional carbon fibre fabrics and epoxy resin using a vacuum infusion moulding process. To the central box is added glass fibre reinforced leading and trailing edge components.

Bearing in mind that the scaled up 10MW wind turbine sails would be 80 meters long, finding ways to reduce weight in the overall sail design was critical. For the prototype, the rotor sail weight was significantly reduced by using a structural adhesive, which had the added benefit of also providing lower overall manufacturing costs compared to a jointed sectional and mechanical assembly design. The carbon fibre epoxy ribs, spars and skins of the box design were bonded together with Crystic Crestomer 1152PA structural adhesive. The leading and trailing edge components, separately fabricated from glass fibre epoxy resin, were then bonded onto the central box of the sail using Crystic Crestomer 1152PA. All the bond joints used a simple joggle design and shim plates to allow for rapid assembly with minimum fixtures and aerodynamically smooth joints (figure 2).

Adhesive selection and bonding

As the adhesive was such a critical factor in both the manufacturing and long term off shore performance of the two light weight rotor sails, Cranfield University



Bonding of sail's U-shaped leading edge assembly to central box

Composites Centre carried out their own detailed study to evaluate a range of possible adhesives for this very demanding application. Andrew Mills, Nova project leader at Cranfield University Composites Centre explained: "The design and scale of the sail rotor structure means that there are large bond surface areas and wide bond lines. The fully cured structural adhesive must, therefore, have long term performance properties which meet a number of key requirements. These include gap filling and providing outstanding peel resistance, while at the same time being strong and very tough, with exceptional flexural strength properties."

The adhesive performance comparative testing carried out by the Cranfield project team was carried out on a range of bond-line thicknesses from 30mm down to 2mm. The test results they obtained clearly showed that the best performing adhesive for bonding both carbon fibre and glass fibre epoxy laminate substrates was Scott Bader's Crystic Crestomer 1152PA structural adhesive. Their findings are supported by the quality and long term performance of Crestomer adhesives having already been proven for over 30 years in many demanding fibreglass marine applications, such as deck and hull stringer and bulkhead bonding, endorsed by both Lloyds and RINA who have certified Crestomer adhesives for of composite bonding a variety marine applications.

For the 10 metre sail prototype, each component and mould tool was designed with joggled part fit, scored fitting positions and 1mm adhesive shims; this provided accurate final sail dimensions without the use of complex assembly jigs. As part of the assembly process to ensure joint accuracy, after positioning without adhesive, each part was drilled and the holes used to either pin or rivet each part together after adhesive application. All of the adhesive joints were post cured in a portable taped foam board oven for 24h at 50°C and joint gaps were subsequently filled with a body filler and abraded smooth using a circular sander to eliminate evidence of the component joints.

SCOTT BADER 01933 663100



Application of Crystic Crestomer adhesive to spar caps and upper skin

HOW TO: JOIN BY CLINCHING

Fastening without fasteners

With today's competitive environment, manufacturers, regardless of their industry, are constantly looking for ways to cut costs without sacrificing quality. The old ways of joining sheet metal components are being replaced by newer technologies – like clinching

Clinching is a cold forming mechanical fastening method to join sheet metal without additional components using special tools to form a mechanical interlock between the sheet metals.

clamps the metals to be joined. Once the metals have been clamped by the stripper, the punch draws a section of the metals into a die in step 2 and in step 3, a die with moving blades, which expand, allowing the metals to flow into a strong interlock.



The Lance-N-Loc method of rectangular clinching is TUV certified

ponents, HVAC, white goods, brown goods, steel frame housing, and office filing cabinets. Over recent years, many more varied business types are starting to use clinching as their preferred method of joining metals.

Many papers have been written on the clinching process itself, including the tool geometries, parameter optimisation, joint strengths, simulation and finite element analysis of the process effectiveness. The Lance-N-Loc method of rectangular clinching has proven to be so successful that in Germany, the process was awarded the prestigious European Quality Standard, TUV Certificate for use in the joining of HVAC ducting flanges.

BTM (UK) Automation Products
01767 677001



Benefits of clinch technology

- Savings of at least 30% over other forms of joining metals; welding, adhesives, riveting, and screwing metals together
- Joins plain, coated, and dissimilar metals
- No rivets, screws, or other fasteners
- Eliminates spot welding operations
- Long tool life: 300,000 joints common
- Joins in a single press stroke
- Non-destructive testing with a simple gauge
- Strong and highly fatigue resistant
- Leak proof joints
- No sparks, fumes, or soot
- Easy to use manually or with robots
- Minimal training required for the operator
- Environmentally friendly

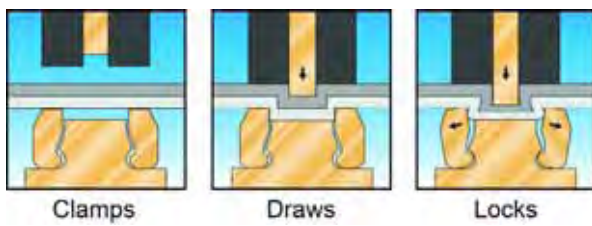

A typical clinch joint is created in three basic steps



The tools consist typically of a punch and a die. There are two primary types of dies: solid fixed cavity dies and dies with moving components. The main advantage of the moving die is its capability to self-clean removing coating deposits, dirt and oil. This type of die requires less force to produce a quality joint resulting in extended tooling life. A further advantage is its ability to be able to join slight variations in metal thicknesses from the original joint set-up. This type of die is more forgiving. The punch forces the two layers of sheet metal into the die cavity forming a permanent connection; the pressure exerted by the punch forces the metal to flow laterally.

No external fasteners or welding is used in the process.

The strength of a clinched joint can be tested non-destructively using a simple measuring instrument to measure the remaining thickness at the bottom of the joint or the diameter of the produced button depending on the type of tools being used.

The two most frequently used geometries in clinching tools are round and rectangular. When round tools are used, the joint has a uniform shear load capacity in all the horizontal directions.

The rectangular clinching joint is commonly used where metals are insufficiently ductile to join using the round joint or in certain dissimilar combinations or multiple layers. The rectangular joint is formed by lancing the metals on two sides, drawing them through the thickness and expanding the width to form a lock on two sides.

The clinching joining method is relied upon and trusted by industries around the world manufacturing a diverse range of products. From stainless steel microwave oven cavities to delicate solar collectors, automotive panels, heat shields, ductwork, garage doors, small electrical com-



A rectangular joint is formed by lancing the metals on two sides

A typical clinch joint is created in under a second and features three basic steps. In step 1, a punch side stripper

FAST

FASTENING & ASSEMBLY SOLUTIONS AND TECHNOLOGY

exhibition

**Fasten it
Fix it**

IASE

INDUSTRIAL ADHESIVES, SEALANTS & ENCAPSULANTS

exhibition

**Bond it
Seal it**

VISIT IT!

**National Motorcycle Museum
Birmingham**

18th October 2012

www.fastenerexhibition.com

Complimentary bacon roll and brew on arrival PLUS FREE Museum pass valued at £8.95 if you pre-register in advance*

*T's & C's apply see website for details



SpecialtyFasteners UPDATE

The clock for machine guard compliance is ticking...



Since 2009, EC Machinery Directive 2006/42/EC has specified that all fasteners on machine guards must be captive. If you have not complied by the end of 2011, you will be in contravention of the directive and will therefore be operating illegally.

You must replace loose fasteners with captive bolts and captive quick-release fasteners. Fortunately, Specialty Fasteners have a range of these products to help you meet the directive criteria. But if you are uncertain of what to do, SFC have a team of applications engineers who will be pleased to consult with you and advise on your situation.

Meet the regulations now – *the compliance clock is ticking ...*

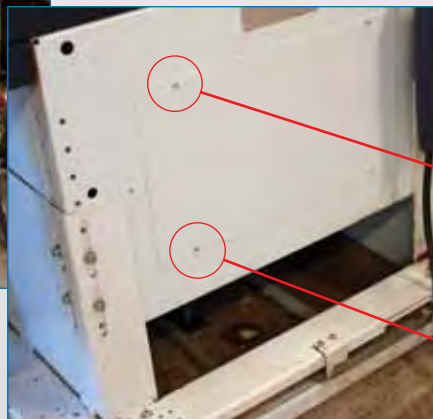

**CAMLOC
CAPTIVE 1/4 TURN
FASTENER**

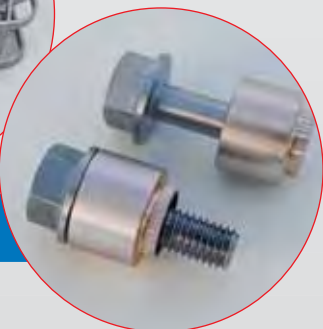

CAPTIVE BOLT

Call an SFC engineer today on
01803 868677
to discuss your guarding
problem or application

www.specialty-fasteners.co.uk/Ad1

ENGINEERED SOLUTIONS FROM



**SPECIALTY
FASTENERS &
COMPONENTS**

Specialty Fasteners & Components Ltd
Seymour Wharf, Steamer Quay Road,
Totnes, Devon TQ9 5AL
Tel: 01803 868677
Email: sales@specialty-fasteners.co.uk



**SEE MORE
SOLUTIONS TO
YOUR FASTENING
PROBLEMS AT**
www.specialty-fasteners.co.uk

Free design service highlighted shrink bonding benefits

Ford Motor Company's decision to adopt heat shrink bonding to attach an auxiliary drive gear to the crankshaft of the Volvo S16 engine was supported by a software package that calculates the bond's retaining strength

Where optimal joint strength is the main requirement, heat shrink bonding is a great solution. The heat in the assembly helps to create a rapid cure and the contraction of the outer component exerts a compressive load on the curing adhesive. The result is a total strength far in excess of the adhesive shear strength and the dry interference strength combined.



Retaining calculation software predicts the strength of metal assemblies bonded with anaerobic retaining compounds

Heat shrink bonding is a technique most commonly used for joining steel to steel. It is also suitable however for joining dissimilar materials for which consideration needs to be given to differential expansion during service.

Henkel has considerable experience in the field of retaining cylindrical components using shrink bonding techniques for similar and dissimilar materials. And its knowledge helped Ford to engineer a Loctite bonded solution that has saved costs as well as guarantee the required performance from the part. The process is now employed in the production of the Volvo S16 short, six cylinder engine at Ford Bridgend.

The components of a shrink fit joint have an interference fit at working temperature but are assembled with a clear-

ance. To achieve this, the outer component is heated and the other, to which the adhesive is applied, is kept cold. This was the method Henkel recommended to Ford for securing steel drive gear onto the steel crank of the Volvo S16 to ensure no movement.

Laser welding was an option but a clear drawback would have been the capital expenditure involved. Bolting the drive gear to the crank was also evaluated but eventually deemed unsuitable as it would have increased the overall weight and size of the engine. So, Henkel was asked to assess the suitability of bonding the structure, which was a process involving a considerable amount of testing and finite element analysis to prove its suitability.

Calculating the unknown

Henkel has many tools at its disposal to assist in finding the best process and adhesive product for the task including extensive laboratory and testing facilities both here in the UK and on mainland Europe. The company has also developed software programmes analysis, one of which was used widely for the Ford project.

This PC-based software programme is called Retcalc plus – short for retaining calculation – and it predicts the strength of metal assemblies bonded with anaerobic retaining compounds. This service is freely available to all manufacturers.

The procedure is simple. Henkel inputs known information supplied by the customer and the software calculates the unknown. So, by supplying the loads and performance required, the program will recommend the most appropriate substrates and joint design. Alternatively if



Henkel's experience in retaining cylindrical components using shrink bonding helped Ford to engineer a bonded solution

the substrate is known, then the load which can be applied in specific environments can be calculated.

Other calculations could include minimum and maximum taper diameter, joint length, clearance and assembly temperature. In other cases details of the operating environment, temperature extremes, the continuous operating temperature and operating medium might be known but calculations involving tolerances are needed.

With more and more design engineers specifying adhesives in their original design, Retcalc is proving invaluable for many companies. It helps to calculate the parameters of designs and as a consequence saves time and cost, ensuring that much of the testing work is completed before any metal is cut.

In Ford's case, the retaining calculation was an important element in proving the suitability of its specially developed Loctite 128467 anaerobic adhesive for the high strength bond. This slow cure product is optimised for the process and is now creating an instant bond between drive gear and crank that has all the performance qualities required by Ford.

HENKEL LOCTITE 01442 278100



AUTOMOTIVE DESIGN

Mass production meets the automotive composites market

Vehicle manufacturers are aggressively adopting lightweight composite material strategies to meet requirements for increased design freedom and flexibility, high strength, stiffness and reduced vehicle weight. Klaus Ritter looks at how the latest epoxy resins are enabling the growth of cost-competitive mass production using automotive composites

The Aventador LP700-4 was the first Lamborghini to maximise the use of composites in its chassis design



Photographs supplied courtesy of Automobili Lamborghini

In mass-market vehicle manufacturing the use of epoxy composites has become widespread. From the early days where composites were used for non-structural exterior applications such as car boots and bonnets, they are now being used for structural applications as well as the mass production of vehicle parts.

Epoxy resins reinforced with fibres produce composite materials with mechanical performance and corrosion resistance properties that are comparable to, if not higher than metal for structural applications. Composite materials offer high mechanical strength, stiffness and better impact resistance.

Substituting conventional materials with composites can reduce vehicle weight, produce better fuel efficiency and improved power-to-weight ratios that lead to an overall better performance.

A major challenge to the use of com-

posite materials has been the ability to reduce production cycle times. Because of this, many manufacturers are re-evaluating their chosen processing methods with a view to speeding up production rates and total production volumes, while also aiming to keep quality at a premium and investment costs down.

Aerospace-derived prepreg materials for autoclave cure were most frequently used within the racing and high-value sectors of the automotive industry. However, for composites to be cost-effectively applied in mass production, both the manufacturing processes and resin systems needed to be adapted accordingly.

New epoxy liquid resins have subsequently been developed for a wide variety of out-of-autoclave processes, such as resin transfer moulding (RTM). Other fast curing epoxy systems and specifically expandable epoxy systems (EES) are

also available for wet compression moulding. Involving moderate investment costs, EES allows the easy and exact moulding of complicated shapes and the possibility of extremely short cycles times up to 45-60 seconds at 145 -160°C.

Carbon fibre chassis

Huntsman Advanced Materials has recently been involved in various groundbreaking automotive composite projects with different global manufacturers. For example, an Araldite RTM system was selected for the production of the first carbon fibre chassis from Lamborghini on the Aventador LP700-4.

The Araldite resin and Lamborghini's RTM-Lambo technique created a robust and lightweight chassis with an excellent power-to-weight ratio. In combination, this system offers a cost effective solution for the quick and repeatable production of structural parts with high mechanical and thermal properties that are comparable to autoclaved prepregs – proof that RTM is fast becoming an excellent industrial solution. For the mass production of parts, however, standard RTM processes needed to be improved and a faster solution for RTM developed.

High pressure systems

Epoxy RTM systems used in automotive applications are bi-component systems and most commonly consist of a formulated resin and a formulated hardener. When the process starts, the chemical components are warmed to the required temperature in storage tanks and kept separate in continuous re-circulation through the circuit of the dosing machine up to the

Klaus Ritter is Marketing Manager Advanced Materials for Huntsman Advanced Materials (Switzerland). http://www.huntsman.com/advanced_materials

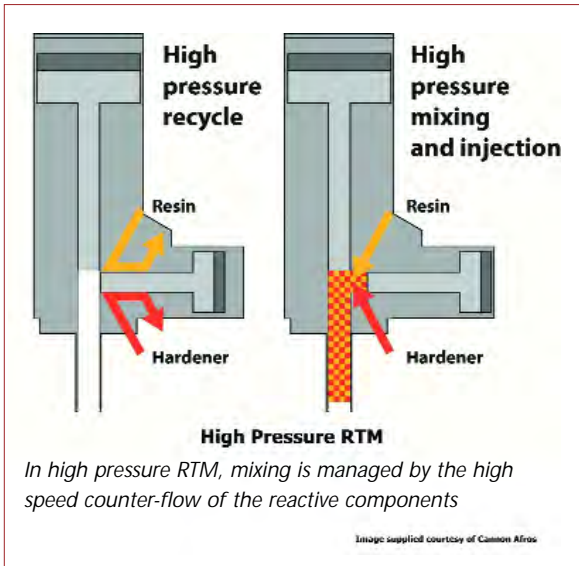

the mould containing the reinforcement, also at low pressure. In comparison, for high pressure RTM, the mixing is managed by the high speed counter-flow of the reactive components with appropriate injectors or 'jets' in a cylindrical mixing chamber (whose diameter can be as small as 4-5mm) at high pressure, most commonly above 50 bars. The chemicals meet and mix thoroughly in the small cylindrical cavity, converting their kinetic energy into turbulence.

The computerised control determines the precise amount of liquid materials required by each different mould and calculates a precise injection time for pump output. When the machine's control sends an injection command, the piston sealing the mixing chamber is operated hydraulically, the mixing chamber is opened and the liquid components are sent through pressure-inducing nozzles.

The laminar flow of liquids leaves the head through an injection nozzle that fits a hole drilled into the mould. All the blended material is therefore quickly transferred into the cavity, without waste. This transfer operation is also performed under very high pressure, higher than 50 bars. The control panel then sends a signal to the hydraulic pack which quickly closes the mixing head and brings it to the rest position. This quick action cleans out the cylindrical wall of the mixing chamber, removing any residual liquid. Therefore, these heads do not require any flushing with solvents or detergents.

With standard RTM, part production in the mould takes between 15-85 minutes. In most cases, a post cure is required to develop the ultimate performance.

With the latest developments in high pressure RTM there is now potential to produce finished parts in 4.5 to 13 minutes, which equates to a significant time saving up to 85%.

HUNTSMAN ADVANCED MATERIALS
(SWITZERLAND)
+41 61 299 2664

inner part of the mixing head. This ensures their viscosity remains constant throughout the process.

Standard RTM is also known as low pressure RTM because the system components (resin and hardener) are usually mixed through a static, helicoidal mixer at a relatively low pressure, most often lower than 15 bar. The mixture then feeds

VIKING
Tapes & Adhesives

3M Tapes & Adhesives Online
FREE Technical Advice

www.vikingtapes.co.uk

the 3M specialists
01535 610373

www.emka.co.uk

SAFETY HAMMERS

DOOR HANDLES

DOOR LATCHES

EMKA
(UK) LTD

Call: 024 7661 6505

VEHICLE ACCESSORIES

TOP TIPS: VEHICLE ASSEMBLY

Safety system reduces downtime by up to 70% in assembly line

A system of safety controllers with I/O modules running on an EtherNet I/P network have helped maximise efficiency in Kia Motor Slovakia's body assembly shop

Kia Motors Corporation (KMC) was founded in 1944 and is Korea's oldest manufacturer of motor vehicles. As part of the Hyundai-Kia Automotive Group, Kia aims to become one of the world's premier automotive brands.

To increase the market share not only in Europe but also worldwide, KMC built its first-ever European facility in Zilina, in Slovakia, and started production in December 2006 with capacity of 300,000 units a year. Kia Motor Slovakia (KMS) produced two models, the Kia cee'd and

KMS's Body Shop was operating with CompactLogix connected with ControlLogix, while its body complete (BC) Line was assembling all moving parts with manual handling by 20 workers. But frequent breakdowns not only decreased productivity, but also sometimes caused the entire line at KMS to stop production.

The BC Line was configured with SICK safety relays and was guarded with SICK safety scanners and relays. The safety relays had complicated wiring and long conductor routing from the safety device to the relay in the main cabinet, without having a by-pass function from the scanners.

The safety circuits or the safety devices caused a lot of small line stops and it was often difficult to identify the reason or the location of the failure while also taking a long time for replacement. Future line stops were always anticipated due to the long and complicated safety wiring circuit.

Relay-based safety controls have a long history of helping prevent hazardous encounters between worker and machine. Safety devices such as scanners and emergency stop push buttons connected by safety relays have been the method of choice to protect machine operators. But relays can offer limited fault diagnostics and are difficult to adapt as applications change because of the hardwiring they require. For these reasons, and considering the critical situation, an alternative integrated safety solution offering status visualisation and higher reliability and flexibility than the incumbent relay system was required at KMS.

Seeking a solution to meet its needs for an integrated safety solution with visualisation and increased reliability, KMS turned to Rockwell Automation— a trusted supplier for many of its operations from the commencement of the plant's production. KMS' automation partner proposed a safety system that comprised safety-related programmable controllers and a network. Safety controller, instead of traditional safety relays, helps customers to create both lean and quick adaptable manufacturing processes that help keep operators safe.

Rockwell Automation offered its Allen-Bradley GuardLogix safety controller, which expands on standard Allen-Bradley ControlLogix processors with safety firmware and a safety processor. Remote safety I/O modules were added and connected to the EtherNet I/P network and visualisation of safety conditions, alarms, emergency events and programming of control system and visualisation was developed for the existing Allen-Bradley PanelView Plus panel. All jobs, including programming and installation, were provided from Rockwell Automation Customer Support and Maintenance (CSM) team.

GuardLogix brings together the benefit of a Logix platform – common programming environment, common networks and common control engine – with integrated safety control in an easy-to-use environment while providing safety integrity level (SIL) 3 control. By deploying ControlLogix processor, GuardLogix users can benefit from common programming software, controller and I/O to help reduce development time and application cost.

In traditional designs, if a person entered the cell or if one device failed



The Kia Sportage was added to Kia Motor Slovakia's production portfolio in 2010

Kia Sportage in 2009. The Kia cee'd model represented more than 80% of the total production. New SUV models, the brand new Sportage and the Hyundai ix35, were added to the production portfolio in 2010, so KMS currently produces three models. SUV models represented more than 50% of all production in 2010. KMS produced 229,505 automobiles in 2010.

Like other automotive companies, optimising manufacturing processes became more important than ever before, to maximise efficiency and productivity. And KMS required an integrated solution where information and devices are connected seamlessly to each other.



Safety systems have cut breakdown at KMS's Body Shop by up to 70%

during production, the entire line stopped. KMS had to check each area and its devices to discover the problem. It was difficult to identify the failure and KMS was unable to figure out which safety button was pushed. The entire line was stopped until the failure was identified and solved.

With the new design, the line was divided into five zones. Each zone had a

cabinet with Safety Point I/O only with 2-3m wiring. Each Safety Point I/O was connected to GuardLogix with EtherNet I/P using RSLogix 5000. Each scanner had a bypass function with the possibility of light signalling and switching.

Now, when the line is interrupted, only the relevant zone is stopped, signalling the location. The operator can also easily communicate with each zone with visualisation through EtherNet I/P. The failure can be easily identified and quickly recovered while other zones remain operational.

KMS considers the Rockwell Automation solution a complete success. By converting to a safety PLC from a relay-based solution, KMS now has a

flexible line with excellent reliability. The flexible platform reduces maintenance and troubleshooting, while helping to secure safety as required. KMS now plans to expand and apply the integrated safety concept to other lines in the body and press shops.

"With the ability to identify the failure and solve problems quickly, we have dramatically increased productivity by reducing up to 70% of the safety breakdown time," said Ondrej Vasek, Maintenance Manager in Body, KMS. "And most of all, the line is easy to maintain and made my life easier."

One of the targets in KMS is to improve efficiency of existing safety lines. As part of its next step, KMS is now considering plans to adapt a similar solution in other lines. And Rockwell Automation's integrated safety solution with GuardLogix will more than likely be considered as the standard platform within KMS.

ROCKWELL AUTOMATION
0870 242 5000

tool solutions that work

Delta Regis range of premium screwdrivers deliver top quality precision screwdriving at affordable prices. Now available exclusively from the UK's experts in assembly cost reduction, Total Airtool.

- Torque range 0.02Nm - 15Nm
- Variable Speed Control
- 3 year warranty*
- Verify count/ fasten
- Slow start Module
- I/O Interface

New
Microdriver



165mm



Accessories include 90deg Angle Head, Pistol Grip, Anti tamper mounting sleeve. Delta Regis products feature non-ESD housings and are fully RoHS Compliant.

Call us on: 01926 857193
www.totalairtool.co.uk

*terms and conditions apply

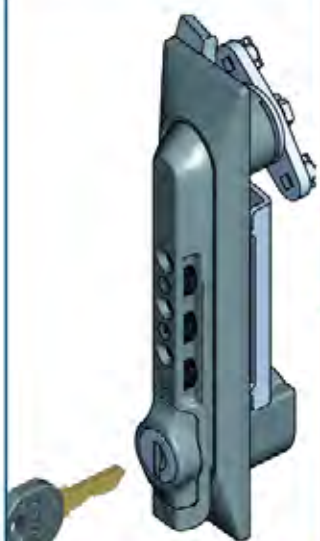

www.emka.co.uk

 <p style="background-color: #0056b3; color: white; padding: 2px; text-align: center;">SWING HANDLES</p>	 <p style="background-color: #00ff00; color: white; padding: 2px; text-align: center;">HINGES</p>
 <p style="background-color: #ffcc00; color: white; padding: 2px; text-align: center;">GASKETS</p>	 <p style="background-color: #0056b3; color: white; padding: 2px; text-align: center;">EMKA (UK) LTD</p>

Call: 024 7661 6505

INTELLIGENT CABINET COMPONENTS

TOP TIPS: LIGHT WEIGHT ASSEMBLY

Fasteners for the assembly of lightweight vehicles

In the drive for automotive performance and economy weight reduction is crucial. New high strength lightweight metals, aluminium, plastics, composites and combinations of all these materials, for body-in-white and component applications have spawned a demand for innovative fastening solutions

Traditional fastening techniques such as spot welding generate heat and can have a detrimental effect on the physical properties of joints of dissimilar materials, assemblies with adhesive layers or surface coatings. Add to this the ever increasing cost of energy and need to replace tooling regularly and it's easy to see why this type of fastening process has lost ground to heat-free mechanical fasteners such as Bollhoff's Rivtac and Rivset.

Rivtac features a high speed, single sided punching/piercing action. The technology is suitable for joining sheet materials including high strength steel, aluminium and other non-ferrous metals, plastics, as well as for composite, multi-layer and hybrid joints in any of these materials. The fasteners can also be used alongside adhesion technology. Joints are achieved in one quick, simple operation without pre-punching and cycle times are minimal.

As the tack penetrates the materials to

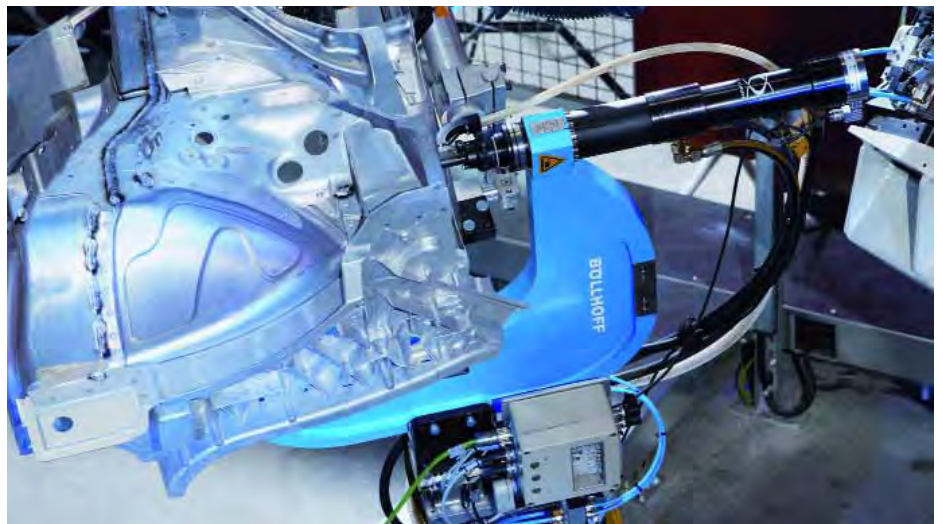

Stationary Rivset tool within an automated robot system in the automotive industry

be joined it generates a short-term rise in temperature at the joint interface and this helps the materials being joined to be displaced into annular ribs on the tack shaft thus delivering a high form fit. Rivtac speed can be adjusted to suit the materials being joined and their overall thickness.

Minimum thicknesses of joints are 1.5mm for steel and 2.5mm for aluminium. Maximum thicknesses are 3 to 6mm. Tensile strengths up to 1600 MPa are achievable.

Rivset is a one-step self-piercing semi-tubular rivet that pierces the upper layer(s) of a work-

piece and forms a locking anchor point in the lower layer. Again this is a simple and fast process that creates high-strength, water and air tight joints without pre-drilling. Repeatable, high quality joints can be made with metallic and non-metallic materials, dissimilar metals of different strengths and in various thicknesses. Typically aluminium (pressure cast), extruded, sheet, deep drawn steels with R_m up to 500 N/mm² and high strength steels with R_m up to 1000 N/mm² can be joined. Multilayer combinations are also achievable with magnesium, copper, films, metal mesh, wood, plastic, fibreglass, sandwich materials and materials with a middle layer of adhesive.

Rivset requires a C frame setting tool or die to be used behind the area where the joint is to be made and it is necessary to design-in access for this tooling. Automatic or manual processing methods can be used for assembly. The positioning of components is simple and tolerances



Automated insertion of Rivnut during the manufacture of white goods



Automotive body assembly with Rivset within an automated robot system



Robot operated Rivset tool

can be relaxed. Again there is no heat input to the application and so no thermal influence on material properties or distortion.

The process is environmentally friendly too. Displaced material remains inside the rivet and there are no fumes so air extraction is not necessary. Noise pollution and energy consumption are also low.

Customisation and tooling

Fasteners are often engineered to suit specific performance requirements. Both types are made from carbon steel as standard but Rivset can be produced in different hardness grades and materials depending on the demands of the joint. Head geometry, shaft length and body diameters can all be changed to suit applications.

A UK prestige performance car manufacturer is currently using Rivset to assemble car body parts. It employs hand held battery tools through to fully automated blow feed machine robots with complete process monitoring systems that measure the force and the distance the rivets are inserted. Both Rivtac and Rivset are approved for use on luxury vehicles produced by several major German automotive manufacturers.

BÖLLHOFF FASTENINGS
01902 637161

Rivnut for automated assembly

Rivnut, Böllhoff's benchmark blind rivet nuts and studs, lends itself to automation across a broad spread of industries. A suite of hand operated, semi-automatic and automatic setting tooling is available to suit most manufacturing requirements.

Offering optimum load bearing and resistance to turning, coupled with corrosion resistance and high temperature compatibility, Rivnut is available in a wide range of head, body and body end configurations. Material choice includes carbon steel, stainless steel and aluminium. The product range extends to high strength thread options in steel and aluminium, ultimate pull-out force design and elastic versions for vibration damping. Blind rivet studs featuring waterproof connections and special designs complete the portfolio.

Rivnut setting is a quick process. The nut is simply spun onto a tool, inserted into a pre-prepared hole, upset and then spun off. Even so cycle times can be reduced further by using multiple head tooling on fully automatic machine tools. Here the nuts or studs are blown to setting heads via ancillary tooling. Sophisticated monitoring and control

devices check every stage of the process.

Engineers at Böllhoff believe that the main benefits of automatic insertion are consistent quality and repeatability - both of which are costly to maintain. Over the years the company has developed a range of stand-alone setting machines - EPK / EPK-c and EPK-hp - for the semi-automatic placement of Rivnut fasteners with full process control. These are ideal for operator dependent installations where fault analysis is required.

High speed automatic installation tools include the SAX 310 Modular setting head, HSA hydraulic setting head with automatic loading system and the ESA - an electrically operated version. Used mainly by production line integrators these hydraulic, pneumatic and electrically powered systems incorporate powerful communication tools which are designed to integrate seamlessly within robotic manufacturing lines.

A global company specialising in the manufacture of composite structures is using Böllhoff tooling to install Rivnut after moulding an automotive front end module assembly.

PROTEX®

Over-centre latches

- Buy direct on-line from the manufacturer
- Mild steel zinc plated or stainless steel
- Huge selection available on-line
- £20 minimum order

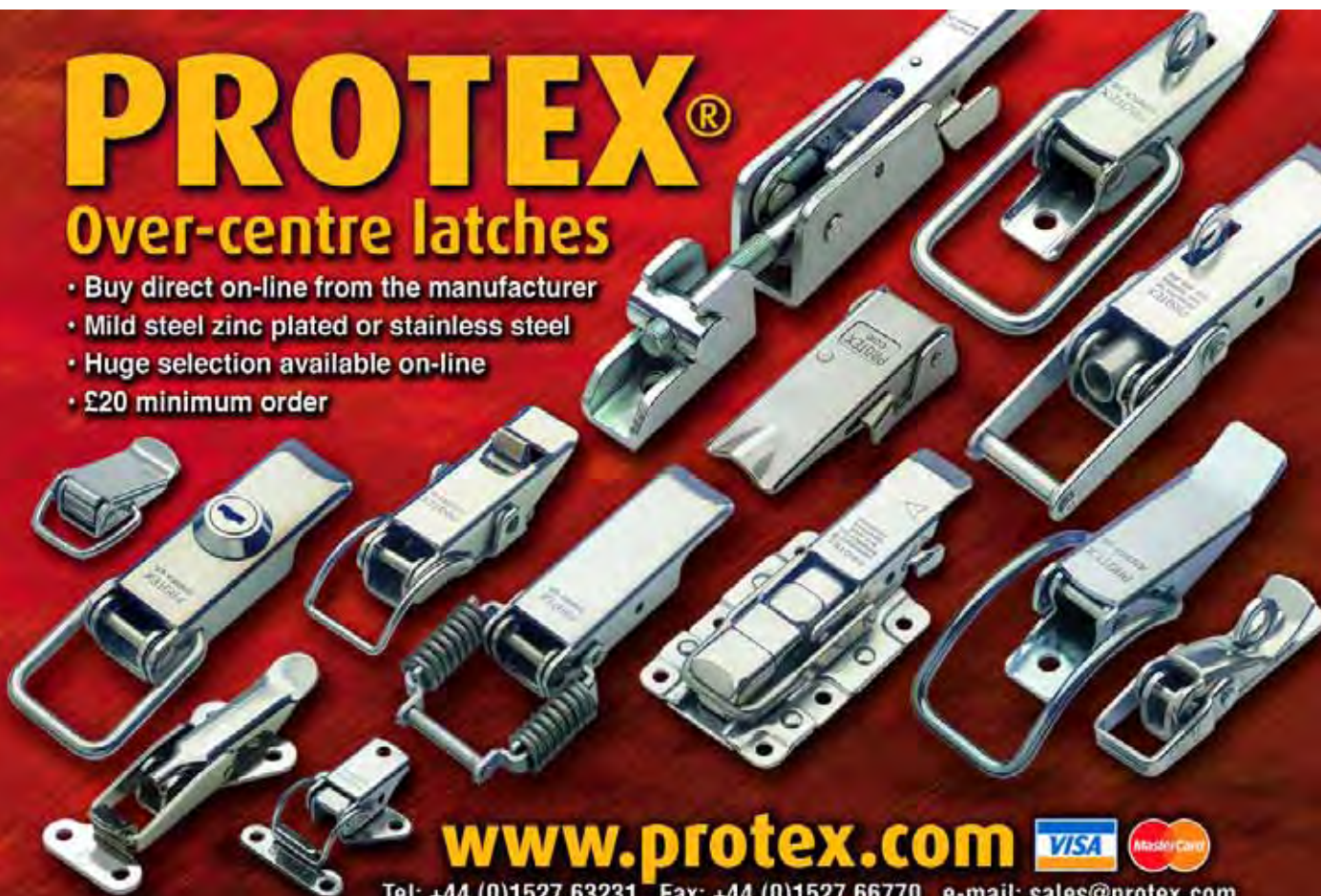

www.protex.com



Tel: +44 (0)1527 63231 Fax: +44 (0)1527 66770 e-mail: sales@protex.com

Stud Welding: with the mega-power – Nelweld N6000

NELSON®
STUD WELDING

The Nelweld N6000

brings stud welding into the 21st century. With its innovative microprocessor control and patented digital user interface the N6000 gives you high power stud welding at the touch of the button.



Nelson Stud Welding UK

47/49 Edison Road, Rabans Lane Industrial Estate,
Aylesbury, Buckinghamshire. HP19 8TE. UK

Tel: +44(0)1296 433500 Fax: +44(0)1296 487930

Email: enquiries@nelson-europe.co.uk

Or visit our web site: www.nelson-europe.co.uk



PRODUCT REVIEW: PLASTIC FASTENERS

Plastic fasteners and fixings range meets increasing global demands

One of Britain's leading manufacturers and distributor of industrial fastenings **TR Fastenings** has launched a range of products range for printed circuit board (PCB) hardware and cable management requirements. The company tells us that plastic fasteners and fixings are set to become a core part of its expansive product portfolio.

Manufactured in nylon 6 and 6/6, the new PCB range includes circuit board hardware, rivets, screws, cable management and wiring accessories. According to TR Fastenings, these plastic fasteners feature extensive benefits which can assist in efficiency and productivity of production processes. Not only can one plastic fastener be used for a variety of purposes but they also have other qualities, including ease of use, being formed from a lightweight material, strength at low and high temperature, resistance to

impact, abrasion, organic solvents and gasoline, retention of shape and stiffness at high temperature. Furthermore, the plastic range meets with the necessary industry standards and sizes, all products satisfy the Restriction of Hazardous Substances (RoHS) compliance legislation, are ISO 14001/2004 compliant and available in flame-retardant versions.

The company is confident that a plethora of application needs, including consumer goods, marine and contract manufacturing industries can be addressed due to the fasteners' versatility. The range will however be especially beneficial in the electronics and telecoms industry, such as ATM machines, PCs, laptops and mobile phones, as well as in lighting.

In such applications, with their closely grouped electrical components, plastic fasteners offer the ideal solution as they



are a non-conductive material. TR has also introduced an extensive range of for effective cable management.

Nylon parts are hygroscopic and are able to hold water molecules drawn in from their surroundings. Therefore, when injection moulded, nylon parts retain latent heat from the manufacturing process and continue to absorb moisture.

All TR's parts have water added before being packed in sealed plastic bags to ensure the

integrity of the material and prevent the parts from becoming brittle, and we strongly recommend continued storage of plastic parts in sealed bags.

Supply capacity for the new range will meet small and frequent orders right up to large contract accounts, catering for next-day delivery on all standard stock items, non-standard is 7 to 10 days. Customised solutions and tooling for new parts are available on request.

TR FASTENINGS LTD 01825 747200

Design of inserts for plastics

PSM International has been regarded as a world leader in the design of Inserts for plastics since the 1970s. In 2012, PSM International launched their revolutionary new Insert for plastics – the Tri-Step Insert. Made from aluminium or brass, the insert is designed for heat or ultrasonic installation into thermoplastic materials. Its design offers the benefits of both tapered and parallel inserts which incorporates two diameters of opposing helical knurls along with a series on annular vanes.

The aluminium insert offers a 66% weight reduction and typically a 20% cost saving compared to traditional brass fasteners, whilst reducing installation time and improving in-hole alignment and location. The product has been well received by both OEMs and Tier 1 and Tier 2 moulders, and it is current-

ly being specified on a number of new automotive projects where high direct torque resistance, a large bearing surface and reduced fastener weight are required.

PSM has recently extended the inserts range with the release of a thin-walled reduced diameter product for applications where space is at a premium. The thin-walled range is available in thread sizes from M2 to M8, in two standard lengths and in a variety of materials. This thin-walled Tri-Step range offers further design benefits such as a lower fastener installation time and a lower in-placed cost compared to currently available fasteners. The thin-walled insert can be used as a value-added replacement to the current Sonic-Lok product

According to Nick Price, PSM Operations Director: "From

the standpoint of customer benefit, the Tri-Step represents one of the most compelling breakthroughs in insert technology in decades. With [this insert], we're not just selling a product, we're helping our customers reduce

cost and improve their manufacturing process. That is truly a rewarding proposition and a win-win for both parties."

PSM INTERNATIONAL
01902 407380



FASTPRODUCTS

Lobe knobs get cushion treatment

Elesa's popular VC series of lobe knobs has been extended with the addition of a product that offers an acetal resin cushioning stud mounted into the end of a stainless steel bolt. This feature coupled with the multi-lobe knob design, enables strong clamping force while cushioning the surface contact and avoiding damage to the material being clamped.

The VC-692-SST-p-P features a comfortable reinforced polyamide based polymer hand knob with M6, M8 or M10 stain-



less steel bolt with chamfered end, into the end of which is mounted the acetal resin button.

Brass ends can be specified to replace the acetal resin standard on special order.

ELESA
01526 322670



Trebling the strengths of constructive bonding tapes

tesa has released details of the products that make up the tesa ACXplus range – a future-oriented category of adhesive tapes for constructive bonding offering additional strengths to very specific types of application.

The range includes tesa ACXplus 705x, a powerful, invisible bonding solution for transparent and translucent materials, and tesa ACXplus 706x which provides excellent immediate adhesion on substrates with a lower surface energy, such as plastics and powder-coated materials. tesa ACXplus 707x completes the trio with long-term resistance against extreme temperatures and outstanding shock resistance (down to -40°C) in cold environments.

The high performance seen in the strength of the tapes' bonding power, stress dissipation and

resistance to both weather and temperature are based on viscoelasticity; a material performance defined by both elastic and viscous characteristics. tesa ACXplus tape technology employs a special acrylic adhesive that combines both effects to provide excellent results.

Dissimilar materials show different elongations when temperatures change and this creates extreme physical stresses that need to be dissipated for the bond to remain durable.

The elastic restoring forces provide inner strength while the viscous part of the material behaviour leads to relaxation of mechanical stresses.

The special balance between elastic and viscous performance secures an optimal wetting of different surfaces and a dimensionally stable and permanent bond, while absorbing dynamic forces and vibrations to relieve any occurring stresses between the bonded components.

The key performance benefits in stress dissipation are uniquely available to these products up to three times the tapes' thickness. In other words, a 0.5mm tape can for example compensate for expansion in bonded materials up to 1.5mm.

TESA 01908 500235



Up to 14 electronic locks controlled by one USB device

The EA-A06 USB controller from Southco allows the computer-controlled operation of up to 14 different electronic locks or other devices when connected to a standard computer USB port. With independently labelled connections for latch inputs, the controller allows simple plug-and-play installation that can be integrated with any Southco electromechanical latch solution.

The EA-A06 features a user-friendly interface with simple programming commands that can be used with existing customer software, simplifying the configuration, operation and monitoring of the electronic devices through a single computer – eliminating the need for additional access hard-

ware or devices. Remote tracking and recording of access can be achieved by connecting to an existing computer.

Field applications engineer Sonny Van Ngo commented:



“When connected to an existing computer, the controller allows remote, secure access control and monitoring of any electronic lock, making it an ideal solution for industries that must comply with regulatory requirements.”

SOUTHCO 01905 346500

A new look at rack access control

The security of a 19 inch electronic racking system starts with the simple things like locks, handles, and hinges but can extend to sophisticated electronic access and monitoring control systems.

Specific requirements are generally met with quarter turn locks and compact or slimline swing handles with rod lock capability, coupled with space and cost saving pin hinges, with simple gasket sections to control ingress, including air flow. Andy Billingham, managing director of EMKA explained: “Zone locking requirements can be met by a traditional multi-key approach or increasingly by keyless locking with radio keys – like the Agent E – or networked and web connectable systems like the ELM electronic access and environmental monitoring and control system.”

The ELM system can integrate externally with end user networks and internally with the cabinet power and sensors such as temperature and humidity or acceleration for monitoring vandalism.

Online access gives the possibility of even wider connectivity including central power monitoring and on/off control for server reboots.

EMKA 02476 616505



FASTPRODUCTS

Threadlocking adhesives designed to be oil tolerant

Eurobond Adhesives comprehensive range of threadlocking adhesives includes an 'oil tolerant' grade. EBA243 is designed to be used on parts in an 'as received' condition such as those with protective oil films. EBA243 is designed for direct application where light oily film exists or where surrounding parts contamination is a problem in maintenance. EBA243 used as a conventional medium strength threadlocker on cleaned parts will offer 12N/mm \varnothing or used as an all-purpose locker on oily parts with up to 10N/mm \varnothing depending on oil type and film. The material will tolerate a temperature range of -53°C to +150°C and will cure in less than 15 minutes at 20°C. EBA243 is available in 50ml bottles

Eurobond Adhesives was established since 1984 and supplies high performance adhesives, adhesive tapes, sealants and coatings solutions through-



out Europe. In addition to its own range of products, the company is UK and Ireland distributors of Panacol Adhesives, Honle UV light sources and measuring equipment and Reinhardt Technik metering, mixing and dispensing machines for one and two-part silicone polyurethane and polysulphide material.

EUROBOND
01795 427888



Latch and hinge technology for industrial use

Our friends at now have available

A useful booklet detailing the development of a modular solution to the need for latches and hinges has been published by **FDB Panel Fittings**. Entitled **Latch and Hinge Technology for Industrial Use**, this pocket book of 95 pages is packed with information from standards and guidelines, IP ratings, installing tips,

actuators, rod latches, mounting arrangements and guidelines on relevant calculations as well as a dip into the arena of gaskets and edge protection profiles.

Many illustrations add clarity to the text, showing the how, what, why and where of latches and hinges as applied to their specification, use and fitment on specialist enclosure cabinets.

Terry Cantle, managing director at FDB Panel Fittings explained: "We are delighted with this pocket-sized edition which I am sure will become a valued companion for enclosure design, production and installation engineers."

The book is available free of charge from FDB Panel Fittings who may be contacted by telephone or by visiting the website at www.fdb.co.uk.

FDB PANEL FITTINGS
0208 568 1616



Instant adhesives can take the heat

Three of the most popular adhesives in the **Loctite** instant range are now temperature resistant up to 120°C, so they can now join almost any material in as little as two seconds across a much wider spectrum of applications. Clean and easy to apply, these products individually provide distinctive and unique characteristics that can now benefit applications where higher temperature exposure is a criterion.

Loctite 401 is Henkel's all-purpose instant adhesive, suitable for rubber, plastics, metals and porous materials such as wood, paper, cork and leather. It is also ideal for smooth, acidic substrates for example, galvanized or chromed components. Loctite 406 is particularly effective at bonding polyethylene, polypropylene and PTFE after

pre-treatment with Loctite 770 Polyolefin Primer.

For applications where non-dripping is a pre-requisite, the improved Loctite 454 is recommended. This general purpose gel is ideal for use on vertical or overhead surfaces. It is also recommended for bonding a wide range of dissimilar materials where large gaps are present.

All three Loctite instants can be readily integrated into semi- or fully-automated production processes for which a comprehensive range of dispensing equipment is available. They are also compatible with dispensing equipment installed for the original formulations so customers wishing to upgrade can do so quickly and easily.

HENKEL LOCTITE ADHESIVES
01442 278100



Australian machine provides a viable alternative to pickling paste

Engineering Utilities has completed an exclusive distribution deal to supply the latest TIG Brush weld cleaning system in the UK. Made in Australia by Ensitech, TIG Brush TBE-700 provides a method of cleaning heat tint from stainless steel and aluminium welds and is claimed to be a viable alternative to pickling paste.

Its key feature is a revolutionary way of combining electrical heat within a brush to apply non-toxic food-grade cleaning fluid. This is non-hazardous and means that companies can dispense with the expensive and time-consuming protection and disposal procedures they have previously used with pickling paste.

The brush's high temperature also simultaneously removes the iron oxide residue produced by the welding process and restores the steel's protective chromium oxide layer – therefore removing the need for a separate passivation process.

The newly-launched TBE-700 drives large brushes and works on both stainless steel and aluminium.

Operating on 110v/230v with auto-switching, it has a maximum reach with extension cables of 18 metres. The machine comes with a complete starter package of brushes and fluids.

ENGINEERING UTILITIES
0113 255 8887

More apps than a smart phone, more torque than Twitter!



From a one-off prototype to large-volume production runs of virtually any type of spring you can imagine, EMO is the leading source of springs and specialised pressings in the UK. Over 170 years of experience is supported by continuous investment in advanced design and manufacturing systems, keeping us at the head of our field.



Springs & Pressings

Geo. Emmott (Pawsons) Ltd. Oxenhope, West Yorks BD22 9NE
Tel: 01535 643733 Fax: 01535 642108
email: mail@emmottsprings.co.uk web: www.emmottsprings.co.uk





Concealed hardware fills the bill for outdoor enclosures

The needs of telecommunications pillars, energy distribution cabs, electronic equipment housings and outdoor monitoring/control stations call for new thinking – now provided by **EMKA** in the form of concealed systems with up to IP65 protection and a high level of resistance to vandalism.

Concealed hardware from **EMKA** includes completely invisible mounting of all catches and hinge components so removing all directly visible points of attack. Active opening and closing is achieved by electro-mechanical operation. When opening the door swings softly out. When closing it moves to the framework and is pulled automatically into the locking device position utilising electro-mechanical locking. The concealed catch is ideal for limited space conditions. Retrofitting is

possible and is not restricted by the type of enclosure.

This, coupled with identification and monitoring, such as by GSM, transponder system or control station as part of a security installation, offers locking, protection, monitoring and alarm functions.

Traditional quarter turn or swinghandle solutions include low profile features in stainless steel, suited to thicker doors and capable of installation with rod locks if appropriate. Internal hinges are also available from the standard **EMKA** program.

Further information on **EMKA** products and services may be found at www.emka.co.uk, where it is also possible to download 3D CAD files and any part or the entire **EMKA** product catalogue.

EMKA 02476 616505

Entry level UV flood lamp cures adhesives and inks

As specialists in the field, the engineers at **Intertronics** are well aware of the advantages of UV curing for adhesives, coatings and inks in the automotive, electronic, optical and medical device assembly industries, where they can greatly speed production cycles, enhance quality and reduce piece part cost. With this in mind, the company is now offering the **DYMAX 2000-PC** lamp as a low cost entry level

genuinely intense UV curing flood lamp. Applications include UV bonding, sealing and encapsulating.

The **2000-PC** features 75mW/cm² intensity over a 200x200mm working area and will get users on the ladder of UV cured benefits, including single-part dispensing and fast cure speeds in the region of seconds rather than hours, with no mess, for a minimal investment.

Bulb life on the **2000-PC** (400W metal halide) is warranted for 2000 hours and there are a range of accessories including mounting stands and shutters which may be retro-fitted. Lamps are offered for demonstrations and trials at the **Intertronics Technology Centre** in Oxford.

INTERTRONICS 01865 842842

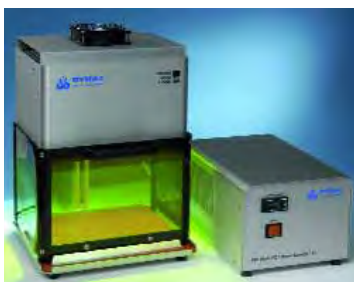

FASTPRODUCTS

Stable epoxy based UV curable system offers high temperature resistance

With its outstanding light transmission properties and optical clarity, **Master Bond UV15** is widely used for a variety of bonding, coating and sealing applications in the optical, electronic and optoelectronic industries. This epoxy based UV curable system is 100% reactive and does not contain any solvents or other volatiles. It is also completely free of any oxygen inhibition.

Like most UV systems, **Master Bond UV15** will cure quickly and easily when exposed to a UV light source with a wavelength range between 320-365 nm. It typically cures in thicknesses of a few microns to 0.015-0.020 inches in 15-30 seconds or less. **UV15** cures by a cationic reaction and produces bonds that have lower shrinkage (1-2%) and higher temperature resistance than most UV systems. Its glass transition temperature (T_g) is 90-



95°C with a straight UV cure. When post cured for 30 minutes at 125°C, the T_g is 125-130°C. The service temperature range for this system is -80°F to +350°F.

UV15 has good resistance to a wide variety of chemicals including water, acids, bases, fuels and many solvents. It features superb physical strength characteristics and electrical insulation properties and its low viscosity allows it to be spin coated. The material has superior adhesion to a wide variety of substrates including plastics, glass and many metals.

MASTER BOND +1 201 343 8983

UV curing adhesive has many uses

The **Vitalit** range of UV curing adhesives, recently made available from **Eurobond Adhesives** is comprehensive and covers a multitude of different applications. **Vitalit** products are typically used in electrical engineering and electronics industries for potting, smart card applications. The adhesives are also used for dome coating, wire tacking, glass bonding, medical device manufacture, plastics bonding as well as optical and opto-electronic applications.

Depending on the application curing times of 0.5 to 60 seconds can be achieved through exposure to high energy UV light. Obviously this shortens cycle times in mass production and makes for a much more efficient manufacturing process. Many products in the range are solvent free, therefore inherently environmentally safe.

As there is no mixing required

and no pot life to worry about, typical benefits of using these products include: simple dosing, immersion, spray or roller application. Low energy costs due to short curing times are also a feature as are the excellent electrical properties and good temperature and chemical resistance.

The short UV exposure time allows bonding of temperature sensitive materials. With their low space requirement, **Vitalit** systems are ideal even for complex fully-automated high volume production lines and can be integrated in existing plants.

EUROBOND ADHESIVES
01795 427888



FASTPRODUCTS

Clamping components enhance adjustable mounting system



Elesa's adjustable mounting system just got much more adjustable – by virtue of a new selection of MSM referenced components which include a clamping base, sensor holding clamps, connecting tubes, L brackets, 2-way connecting clamps, flanged bolts and square mounting tube.

Elesa's new MSM components add considerably to the functionality of this already adaptable system which may be used on equipment of all types – and is especially popular for mounting of optical sensors and similar equipment on conveyors or machine feeds. Clamping elements may be used with Elesa's GN511 push button clamping handle for rapid re-positioning or adjustment. The system consequently offers a quickly assembled and robust framework for installation of monitoring and control equipment which may be readily adapted to the overall needs of production or logistics processes.

ELESA 01526 322670



Locking swinghandle accepts HID proximity cards

A recently launched electronic locking swinghandle from Southco has an integrated proximity reader, which includes the same intelligent electronic locking and monitoring features as the original model but also accepts HID 125 kHz prox cards or tags and produces a standard 26 bit Wiegand output. This fully integrated swinghandle can be easily combined with any new or existing Wiegand-based access control system to add additional keyless entry points to active security systems, and incorporates existing operator credentials.

The H3-EM features a simple, single-hole panel preparation, making it compatible with industry standard enclosures for OEM integration or field retrofits.



When connected to an access control system, the reader also enables the user to easily track and record access to the electronic locks, providing an audit trail to demonstrate compliance with regulatory requirements, such as HIPAA, HITECH and Sarbanes-Oxley.

SOUTHCO 01905 346500



MACHINE ACCESSORIES 1000's of Capabilities

Our Machine Accessories ideally suit assembly and fastening applications. With our ever increasing ranges of enclosure parts, we will have the product for you. From Quarter Turn Catches, Handles and Latches to Hand Knobs, Hinges and our latest new product - Gas Struts available with a great range of end fittings.

The comprehensive WDS product range is manufactured in plastic, steel, stainless steel, aluminium and cast iron. Our vast selection serves many industries including food, pharmaceutical, automotive, packaging, aerospace etc.

WDS supplies parts for maintenance and repair, rebuild and refurbishment and OEM applications.

Download our 2D/3D CAD Models and technical information free of charge from www.wdsitd.co.uk

Tel: 0845 606 6677
Fax: 0845 601 1173
Email: sales@wdsitd.co.uk



FASTPRODUCTS

Getting to grips with recessed handles

The latest range of recessed handles from WDS provides OEMs across all industries with a solution for doors, hatches, machinery and mobile equipment. Manufactured from a choice of materials, including stainless steel, the recessed handles can support heavy loads while closing flush when not in use, making them easily accessible when needed without causing potential obstructions.

Convenience of purchase is such a key factor in supplying standard parts that UK market leader WDS has developed it into what it terms an art form: every product in the new range of recessed handles is available as a CAD download file from the comprehensive WDS catalogue website www.wdsltd.co.uk and all items can be ordered individually without a small order sur-

charge, a fact that will please designers and maintenance engineers looking for replacements.

Chris Putman, sales and marketing director, commented: "At WDS we believe that if customers only need one item they should be allowed to purchase just one item; we won't penalise customers with minimum order surcharges or minimum order quantities. Add that to reduced carriage rates when purchasing online, discounts for large quantities and next day delivery and I believe WDS offers the complete package."

The latest products from WDS all feature spring loaded return mechanisms and are available in a range of shapes and sizes; a choice between zinc plated steel or stainless is available, meaning they are suitable for most environments. As with most



WDS products, the handles are stock items which are available for next day delivery in most cir-

cumstances; also available are zinc plated steel support plates. WDS COMPONENTS 0113 290 5845



Richco

Design, manufacture and supply of plastic components

With many years of experience, customer focus and innovation we are able to help our customers in our core areas of design, manufacture and sales of plastic and metal fasteners.



Visit our website today for full product details, order a catalogue or samples and download 3D models.

www.richco-int.com



Richco International Co Ltd Richco House, Springhead Enterprise Park, Springhead Rd, Gravesend, Kent DA11 8HE UK
 tel: **+(44) 1474 327527** fax: **+(44) 1474 327455** email: sales@richco.co.uk web: www.richco-int.com

FASTPRODUCTS

New generation superglues meet high tech demands

Superglues have come a long way from the general purpose domestic product we have all become familiar with. The adhere ADH9105 product from



Intertronics is an excellent example of a precision engineered application specific adhesive for the high technology industries. ADH9105 has higher impact, humidity and temperature resistance with a more flexible bond than mainstream cyanoacrylates, making it the adhesive of choice where gap filling and resistance to vibration,

thermal shock or motion compliance are required. This characteristic is particularly relevant in the mounting of electrical or electronic components, assembly of enclosures, cable boxes or in strain relief or simple wire tacking, such as in loudspeakers.

The adhesive is a high viscosity black rubber toughened formulation that can tolerate intermittent temperatures up to 125°C and is suitable for bonding metals, plastics and rubbers providing a bond of suitable flexibility, even capable of withstanding wave solder processes.

This tough peel and cleavage resistant one-part adhesive features room temperature cure in seconds without an external energy source. At 3500-5000 cps viscosity, the material will not droop, run or sag before cure is completed.

Dispensing is readily achieved in small quantities using standard squeeze bottles. Larger quantities, perhaps for flow line production, are dispensed by pressure pot, manual, semi-automatic or fully automated equipment, all available under the adhere brand.

INTERTRONICS
01865 842842

Angle tool gets new head



The latest Delta angle tool from Total Airtool Services incorporates a new angle head, which fits easily to an existing tool, the ESL M, which is already produced with an aluminium front body that facilitates fixture mounting so it lends itself naturally to the angle head.

There is no loss of power or

accuracy so the angle range can produce up to 15Nm with speeds ranging from 350 – 1000 RPM. And as with all 40V Delta tools, the new angle drive can be used with the BECT640SSOe count and verify controller.

TOTAL AIRTOOL
SERVICES (UK)
01926 857193



Stable epoxy resists high temperatures

Formulated for electrical potting and encapsulation applications, Master Bond EP36AO combines high thermal conductivity with thermal stability. This flexible, heat resistant epoxy has superior mechanical properties.

Serviceable over the wide temperature range of -80°F to +500°F, EP36AO provides high performance in harsh conditions. Once cured, it features solid electrical characteristics including a dielectric strength of 400 volts/mil, a volume resistivity of 2-3 x 10¹² ohm-cm and good thermal conductivity. This system has a coefficient of thermal expansion exceeding 75 in/in x 10⁻⁶/°C at 60°C and a tensile strength of over 2,000 PSI. EP36AO is a capable adhesive and coating that adheres well to both metallic and non-metallic substrates and it features long-term chemical resistance to an array of organic and inorganic chemicals.



As a one component system, EP36AO doesn't require any mixing and offers the convenience of flexible cure schedules. A typical gel time is 30 minutes at 180°F, with full cures attained in two to two and a half hours at 300°F. This can be shortened further at higher temperatures. EP36AO will retain its liquidity as long as the temperature does not exceed 180°F. It is supplied as a solid and has a minimum shelf life of three months but can last as long as six months in its original unopened container.

MASTER BOND +1 201 343 8983

Camlock systems ensures safe workplace

Multiple Electrical Engineering Services (MEES) designs, manufactures and installs electrical control systems for industrial machinery such as lathes, milling & grinding machines. In order to ensure overall safety, MEES counts on custom-built interlocks manufactured by Camlock Systems.

The electrical control system manufactured by MEES features a switch unit that ensures only suitably qualified personnel operate the machines and helps to protect manpower servicing or repairing them.

To meet the precise requirements, Camlock Systems provided a 10 pin interlock cylinder, fitted to a Kraus & Naimer CA40 40 AMP, 4 Pole Switch. The lock keeps the key trapped during usage and enables the user to remove it only when the machine is switched off. The key that

operates a particular machine is identified by the colour of the key fob. This colour coding system also ensures that only personnel with suitable training and experience operate a specific machine.

Peter Boulton from MEES commented: "We chose Camlock Systems because we had worked with them in the past and our experience was very positive. We especially appreciate the professional service."

CAMLOCK SYSTEMS 01323 410996



FASTPRODUCTS

Epoxy resin boasts great performance in high temperatures

Four different hardeners have also been introduced to accompany Sika's latest epoxy resin just made available from **John Burn**. The four versions have similar properties but vary in working times, ranging from 60 to 210 minutes.

The CR132 product can be used to build light aviation as the resin can perform in temperatures exceeding 130°C and is therefore capable of withstanding intense solar heat.

Biresin CR132 resin is a hand laminating base system with three hardeners, which offer similar properties but have varying pot lives, from 60 to 210 minutes, allowing for efficient production of different size parts. These systems can reach temperatures of over 130°C when properly cured. Due to this they are suitable, for example, the production of dark painted aircraft. Despite solar heating on the aircraft skin due its dark paint, the system will still perform to a high standard and be thermally stable.



Based on the properties of the base CR132 epoxy resin and using the building block principle, two further resins have been developed for flame retardant specifications. They can be used in the production of cowlings and fireproof bulkheads using hand lamination.

With a combination of three resins and just four hardeners Sika can offer a complete product family in the form of a modular system, that delivers high performance results in a wide variety of applications. Their special properties are not only required in light aviation. The products are also available for general industrial use.

JOHN BURN 0121 508 4144

Enabling screwless designs

PEM unthreaded Keyhole and Snap-Top standoff fasteners provide ideal solutions to mount and detach PC boards, panels, or components easily without requiring any tools or additional hardware. Both families of RoHS-compliant fasteners are designed to provide secure and reliable attachment, reduce or eliminate risks associated with loose hardware potentially damaging internal circuitry, and ultimately enable screwless designs of sub-assemblies.

Keyhole (type SKC) stainless steel self-clinching standoffs allow for a PC board or panel to be slipped quickly into place and then removed from an assembly by simply sliding the board sideways and lifting it off. Further security can be achieved when used along with a single threaded standoff.

Snap-Top (types SSA, SSS, and SSC) aluminium, steel, and stainless steel standoffs clinch into metal sheets and type KSSB brass standoffs broach into PC boards. They employ a spring

action to hold boards and panels securely, while allowing for their quick attachment and removal using a simple snap-on/snap-off operation.



All install permanently in sheets or panels as thin as 1mm by squeezing them into a properly sized hole using a standard press. On installation, the fasteners become integral parts of the assembly.

Detailed specifications for standoffs and free part drawings can be accessed at www.pem-net.com

PENENGINEERING
+353 91 7471186

Scanner welding with nine selectable axes

A scanner welding system (SWS) from Rofin-Baasel UK is a fast beam deflection system used for robot guided multi-spot welding and specifically developed for use in conjunction with fibre laser series which is available with output powers of up to 4,000 W.

The fibre laser can be integrated into fully automated welding systems, in combination with a 3D scanner and the RobotSyncUnit. The flexibility of SWS enables complex 3D components to be welded. By combining the axes of the scanner with those of the robot as the presentation mechanism, the system commands a total of nine selectable axes.

Regardless of weld type - spot, circular, wave or stitched seam, the seam geometry is

freely programmable and can therefore be configured to specific strength and component requirements. The high-speed rotating mirrors in the scanner head allow extremely fast positioning of the laser beam, (in the ms range), across the working field. Robot movements and speeds can also be optimised using optional offline programming. These features minimize the non-productive time between weld positions to provide high process utilisation.

The new scanner head doesn't need an expensive flat field lens and therefore sets new standards for scanner welding in the harsh industrial environments often found within the automotive industry and other production environments.

ROFIN-BAASEL UK 01327 701100



star

FASTENERS

www.starfasteners.co.uk

THE UK'S
LARGEST
DISTRIBUTOR OF



• HUCK®
FASTENERS

• QUALITY
RIVETS

• THREADED
INSERTS

• TOOLING
- Sales
- Hire
- Repair



T: 0115 932 4939

F: 0115 944 1278

E: sales@starfasteners.co.uk



Fixed. And fastened. By Hopwood.
In partnership with EJOT



EJOT Easyboss & Ejobt Delta PT Screw.
The perfect fastening combination.

Lightweight, recyclable, super anti-vibration performance.

Need help with your specification?

Tel: +44 161 429 6066

E-mail: sales@rhf.co.uk

Hibbert Street • Whitehill Ind. Estate
Stockport • SK4 1NS

Leading the way in fastener
distribution, quality and service

www.rhf.co.uk

Fix it...Align it... Snap it on or off...

Fasten it your way with Böllhoff innovative fastener technology. Engineered to suit your application requirements.

- SNAPLOC® – reusable, high performance vibration-free, noise reduction fastening
- FLEXITOL® – stepless tolerance compensation fastener
- RIVNUT® – blind rivet nuts
- ONCERT® – ultra- fast light curing fastener bonding system
- RIVSET® – self-piercing rivets
- RIVTAC® – self-piercing blind fasteners
- RIVCLINCH® – Metal joining without fasteners



BÖLLHOFF

Joining together!

Call us today for details 01902 637161

Böllhoff Fastenings Ltd Willenhall WV13 2JW
E-Mail: enquiries@bollhoff.com • www.bollhoff.com/uk

Everything but the vehicle

A range of commercial vehicle accessories from EMKA focuses on items such as emergency hammers, door handles, luggage compartment handles, locks, latches, storage nets, cup holders, air vents, strikes, toggles and similar items. The range builds on the company's extensive program of moulded sealing profiles and custom formed gasket rings and frames with vulcanised corners – which have met a significant need within the commercial vehicle industry

Applications for EMKA's recently launched range of commercial vehicle accessories include buses, coaches, earth moving equipment, military vehicles, transfer vehicles, trains, light rail, generators, trailers, trucks, glazing panels, recreational vehicles, cabins, caravans, ships and boats, special vehicles, cabinets, enclosures and general 'industrial' situations, as well as off-road vehicles, subways, trams, railway carriages, mobile homes, municipal vehicles, horse boxes and emergency service vehicles.

The company's traditional product areas also meet the needs of the commercial vehicle sector, including standard and custom hinges, as well as the sealing profiles for which EMKA are already well known. These are ideal for gasketing, edge protection or decorative purposes and are available in rubber, plastic and metal spined types.



with matching striker plates.

The latches work with a variety of handles, including luggage door flap handles and pushbutton cab door handles, and may be actuated mechanically by rod system, pneumatically or electronically.

They are ideal for doors on all types of commercial or related vehicle, such as railways, light rail, off-road, horse box, mobile caravan, mobile home etc. Features include extreme load capability appropriate to the commercial vehicle industry with full 100,000 cycle performance and supply of all necessary accessories for installation – such as internal releases, locking bolts, mounting screws, plastic covers and even rectangular round tube with integrated release.

The company's luggage compartment handles are commonly used on the side and underside of coaches and other passenger vehicles, also on engine covers where they enable secure closure with ease of operation and access. These are matched with compatible latches and passenger door handles and are built on the company's extensive programme of moulded sealing profiles, gasket rings and frames with vulcanised corners.

EMKA's traditional hinges,

locks, handles and other hardware also meet the needs of the commercial vehicle sector, including standard and custom hinges, as well as the sealing profiles for which EMKA are already well known. These are ideal for gasketing, edge protection or decorative purposes and are available in rubber, plastic and metal spined types.

Cup and can drinks holder



How many cup holders do you want in your cab sir? How many can or drinks holders in your coach? Well, now commercial vehicle manufacturers can buy standard 70mm dia. fold-away holders with multiple fixing options for installation wherever required without having to design-in.

EMKA's drinks holders have a quick opening and snap shut, fold-away design. They are moulded in PA66 polyamide and are available in a variety of colours on request.

The stowage net knows its place

The humble stowage net finds its place in EMKA's new program of commercial vehicle components with a wide range of custom shapes and sizes, also mesh

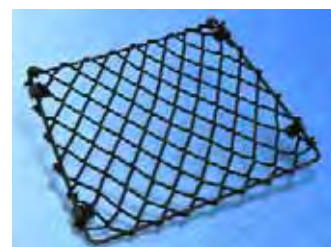

shapes, mesh sizes and many configurations, including frame types and various mesh material specifications with or without metal frames.

The nets are expected to be of value for cab stowage or seat back application, such as in coaches or rail applications. On floor storage nets may also be matched with foldaway D rings for securing luggage.

Emergency hammer could save the day

A T type emergency hammer has a quick removal clip fixing bracket for easy installation in vehicles such as coaches, railway carriages and similar where hardened tip hammers are a vital safety feature for exit through toughened glass windows. They are TUV tested for 5mm safety glass.

The hammer is complimented by a pistol grip anti-vandal version with wire attachment reel preventing removal, both types are offered with matching clip mount. It hammer weighs 72 grams and has been designed to enable comfortable use by people of varying age while providing sufficient impact force to break glass quickly. Handle colour is red for easy identification.



Vehicle locks, latches and handles

Getting the combination right in selecting matching handles and latches is an important matter for easy operation of an installed system, so these new EMKA latches for commercial vehicle applications will help in combination

Further information may be found at www.emkblog.co.uk/vehicle-accessories or download a brochure
EMKA 024 7661 6505

FASTPRODUCTS Fastener security

Vibration-proof fasteners which are easy to undo



The SBS product from **International Engineering Co** (IEC) has been extensively tested and has been found to perform much better than common fastening solutions such as flat, spring or conical washers. Furthermore it has been tested against established products specialising in

high vibration applications and found to perform equally as well or even better whilst holding significant benefits of being easy to install, easy to undo with standard tools and being completely reusable. Opting for the tamper resistant option makes the product unique in offering both security against tampering as well as vibration resistance.

“One of the great things I’ve found with demonstrating this product is the smile you get when people realise how simple yet effective this fastening system is,” said Peter Keen, Engineering Division Sales Manager for IEC.

“There are a lot of very good systems on the market and in terms of fastener security it would be naïve to say this system is better than any of the others. Often overlooked is whether the fastener needs to be undone within the life of the product and then how easy it is to do this. Adhesives do

exactly what they say and form a secure joint that is very hard to break. Mechanical systems work on the principal of imparting a loading force into the bolt that counters its ability to release itself under load or vibration.”

The SBS system works on a pair of washers having wedge shaped ramps formed on its face which on assembly mate together. The underside of washer has a series of serrations that will achieve an extremely effective grip on the housing when the fastener is tightened down. If you try to undo the fastener by locating on the bolt head or nut only you will find it impossible to loosen. This is because the angle on the wedges is greater than the pitch of the thread and therefore by trying to move the nut/bolt relative to the washers you are in effect tensioning the bolt and increasing the locking force.

In order to loosen the fastener

it is necessary to turn the bolt head or nut together with the washer, which using the SBS system can be done using a standard spanner or socket. This is where the system is different from its competition which use round washers and so are far more difficult to undo using standard tools.

An extension to the SBS hexagon washer system is to use round washers in the same configuration which have lugs cut into the outside edge. Using a special socket which locates in the lugs the fastener can be undone as easily as the hexagon version but can be deemed as tamper-proof by virtue of needing a dedicated tool to undo it. Depending on nature of the product or its location this may be an added benefit to the customer or user.

**INTERNATIONAL
ENGINEERING CO**
01202 339559



tesa

Experts in tape engineering

For help and technical advice on our range of double sided, masking, and cloth tapes or converted products please phone:

01908 500235

for your nearest authorised tesa distributor

tesa UK Ltd
Womans Drive, Bicklands, Milton Keynes, MK14 6LS
Tel: 01908 500235
www.tesa.co.uk
www.tesa.co.uk

For all your fastening needs

Visit us at FAST Exhibition,
National Motorcycle Museum,
Birmingham on 18th October 2012

call now to speak to our expert team
+44 (0) 1922 740400
www.tfccavalier.com

Innovative tamper-proofing for sensitive equipment

In light of constantly evolving industrial expertise in all sectors, protection of highly sensitive equipment against unauthorised access is becoming more and more important. A new tamper-proof fastener system provides maximum security, cannot be loosened using conventional means, reduces costs by eliminating supplementary assembly

and security material, while ensuring it is interchangeable with existing fastener systems, it is claimed by the product manufacturer Arnold Umformtechnik.

Using special fasteners to secure sensitive equipment has been common practice for many years. A wide variety of more or less practical solutions have been devised, including breakaway screws and nuts, secure drive systems that require special tools for loosening, and hammering small ball bearings into drive recesses. In response to the need for improvements to existing systems, **Arnold Umformtechnik**, a manufacturer of innovative fastener systems, has developed the LocTec screw drive.

This system combines a special screw drive geometry with its own assembly tool, making it impossible to loosen

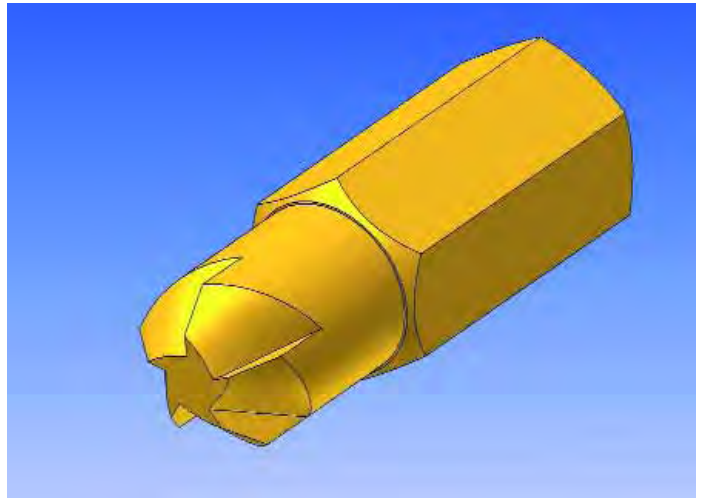

or remove the fasteners without destroying the joint. The patented system is designed so the flank shape of the drive recess makes it impossible to loosen the screw after assembly, even with the special tool. Attempting to do so causes the tool to rotate out of the screw head on its own.

Dismantling is only possible by drilling out the screw or cutting a slot in the screw head. Both options void the warranty, and they hinder theft due to the considerable amount of noise generated by these processes.

ARNOLD UMFORMTECHNIK
+49 7947 821 170

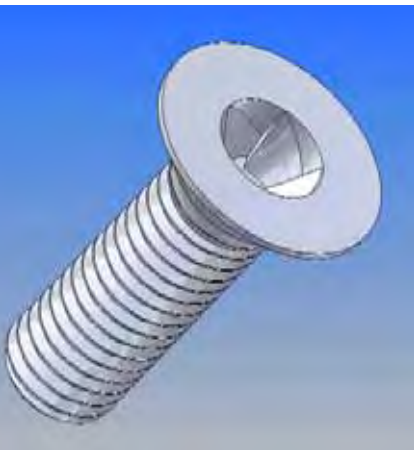

Eliminate Unnecessary Cost Maximise Your Profitability



Speed up weighing tasks, increase productivity and improve compliance with ICS compact scales.

- Simple and error free weighing
- Intuitive menus and fast user prompting
- Smart colour display

These compact bench scales provide flawless connectivity, a centralised database and smart printing solutions. This enables easy, accurate and reliable data export and import.



Watch the ICS scales in action

► www.ml.com/ind-ics5-easy

Mettler-Toledo Ltd
Call: 0116 234 5095
Email: enquire.mt.uk@mt.com

METTLER TOLEDO



GESIPA





THE EXPERTS IN BLIND RIVETING SOLUTIONS

THE UK'S LARGEST SUPPLIER OF:

- COMPLETE SOLUTION SUPPLIERS
- BESPOKE PRODUCT CAPABILITIES
- GLOBAL MANUFACTURING FACILITIES
- EXTENSIVE RANGE OF RIVET & RIVET NUT BASED SOLUTIONS
- ISO 9001, TS 16949 & ISO 14001 APPROVED



GESIPA Blind Riveting Systems Ltd
Dalton Lane, Keighley
West Yorkshire, BD21 4JU
United Kingdom

Tel: +44 1535 212 200
Fax: +44 1535 212 232
Internet: www.gesipa.co.uk
E-Mail: info@gesipa.co.uk

Manufacturers of rivets, rivet nuts, tools & bespoke rivet based solutions

FASTTAILPIECE

Middle East latch logistics

The production staff at FDB Panel Fittings pulled all project strings together successfully to deal with a Middle East based enquiry from a client requiring locks for 18,000 galvanised steel boxes designed to house water meters.

The specification called for a securing of the enclosure door with a plastic clip-in, quarter-turn latch – simple to fit and, bearing in mind the quantity, relatively low in cost. However, the enclosure manufacturer sought guidance from FDB Panel Fittings to confirm the specification. Managing director Terry Cantle explained: “We felt that the proposed plastic latch would be unsuitable for the service conditions that were likely to be encountered by the boxes.” So a small but extremely robust

diecast lock with steel cam was suggested for evaluation by the client. “In order to stay within the budget constraints we proposed that the lock be supplied zinc-plated rather than its usual chrome-plated finish,” added Terry. “FDB then supplied sample locks to incorporate into the prototypes and subsequently to gain the approval of the client to proceed.”

The next task was to set about addressing the logistical supply chain problems to meet the short timescale required as the box manufacturer had been given only three months to complete the contract and, with a fixed completion date in place had set up additional facilities in order to meet the production schedules. “There could be no slippage on delivery of the locks as twelve, 40 foot

containers had been pre-booked for the shipment.” Terry explained.

FDB began to deliver at the required rate of 1500 locks a week but after four weeks increased this to 2000, thus facilitating completion of the contract in 10 weeks. The delighted manu-

facturer stated: “We invested a considerable amount of time and money in planning and producing the enclosures at the required rate so it was vital that the supplier of the locks was able to keep up with the schedule and FDB did not let us down.”

FDB PANEL FITTINGS 020 8568 1616

Further information on FDB Panel Fittings products and services may be found at: www.fdb.co.uk. Readers could also check for news and the latest information on the FDB blog at: www.panelfittings.co.uk or follow on twitter: www.twitter.com/fdbpanelfitting

Geraldine takes the helm at CBM

For the first time in its long history, Britain’s biggest industrial trade association has awarded its top job to a female. Operations director Geraldine Bolton has taken charge of the West Bromwich-based Confederation of British Metalforming (CBM), which traces its origins back to the early 1900s. The appointment came after the CBM executive board agreed unanimously that she was far better qualified than any external candidate.

“I really couldn’t be more pleased or more proud. You’ll never find anyone more passionate about the CBM, or more committed to its success, so it really is my dream job,” said Geraldine. “I was quite content being the company secretary, when my boss suggested I should top up my qualifications by taking a degree in business management, and I completed my studies with Essex University last year.

“It was a combination of distance learning, and web-based lectures, which was very



demanding, as I also worked full-time, but it was certainly worth the effort,” Geraldine quipped. “I thought when I graduated that I might have a chance to play a different role, as the CBM was going through a strategic review of its operations, but I honestly didn’t believe I’d end up being asked to take charge.”

The review was carried out by acting chief executive Dennis Kent, a long-time CBM board member who had time on his hands, after selling his Leicester-based Carlton Laser business to a buy-out team. “One of the critical challenges was to look at which of the staff could take on new responsibilities, and we were all really impressed by Geraldine, in terms of experience, nous and personality,” he said.

CONFEDERATION OF BRITISH METALFORMING 0121 601 6350

£100 CASH QUIZ!

Win a cheque for £100 from the publishers of FAST Magazine!

Submit your answers by faxing this completed entry to us on 0845 280 1587 or emailing them to quiz@fastmagazine.co.uk with your name, job title, company name and contact number. A draw from all correctly answered entries will be made in the FAST Magazine office on 3rd December and the winner notified by phone and email. The winner will also be announced in the next issue of FAST Magazine, published in January 2013.

1. Percy Pilcher was a British pioneer of what?

- Chemistry Gliding Atomic research

2. What did Lotus Cars founder Colin Chapman study at University?

- Structural engineering Materials science
 Electrical engineering

3. In which part of the Army did steeplejack Fred Dibnah serve his country??

- Kings Hussars REME Royal Artillery

4. What was the first of HM ships in which future explorer Captain James Cook served?

- HMS Solebay HMS Resolution HMS Eagle

5. Which was the first State to ratify the Constitution of the United States in 1787?

- Rhode Island New York Delaware

6. Who bought the Volvo Cars brand from Ford Motor Co in 2010?

- Tata Motors Zhejiang Geely Holdings Renault-Nissan Alliance

Winner of July quiz was Caroline Merdith of Host Systems, Tewkesbury. Congratulations Caroline! The correct answers were:

1. Bristol made a name for its sleeve valve engines in the 1930’s. 2. Sir Frank Williams was born in South Shields. 3. Michael Rutter won the TT Zero race this year on an electric motorcycle. 4. The clipper ‘Cutty Sark’ was built in Dumbarton. 5. In 1891 future car maker Henry Ford worked for the Edison Illuminating Company. 6. Distinguished fighter and test pilot John Cunningham left a legacy to assist young people keen to fly. Our thanks to the many readers who entered.

The National Motorcycle Museum



SHOWGUIDE

**National Motorcycle Museum
Birmingham**

18th October 2012

0830-1400



WELCOME



Get inspired and join us at the exhibition

There really is no substitute for speaking face-to-face with the leading experts in any field, and if you're interested in the latest 21st Century fastening, bonding and assembly products and practices there is no substitute for visiting: this is the UK's only exhibition dedicated exclusively to the subject.

Whether you're involved in design engineering, production engineering, R and D or are running a manufacturing company, there are thousands of very good reasons to attend: the thousands of products coupled with the hundreds of methods and dozens of leading suppliers available for you to discover and discuss your needs with.

The exhibitors' personnel are all seasoned application experts who have helped some the UK's best engineers and manufacturers overcome challenges to improve product quality and reduce costs.

Pre-register in advance as a VIP Visitor at www.fastenerexhibition.com and claim your free museum pass (otherwise priced at £8.95) plus complimentary bacon roll and brew on arrival. Parking is plentiful and free and the venue is on the roundabout at J6 of the M42. Finally, the doors open nice and early at 0830 for a reason: to allow those of you wanting an early start to get in to the show, get round, get some answers, ideas, inspiration and contacts and still be back in the office by midday or early afternoon. Looking forward to seeing you there.

Paul Gay,
Editor, FAST Magazine

Collect your floorplan and Addendum on arrival!



Mouse finds fasteners

www.fastening-solutions.com

ADCO (UK) LTD



Unit 9, Fernhurst Business Park
Midhurst Road, Fernhurst
Surrey GU27 3HB

t: 01428 661717
f: 01428 651671
e: enquiries@adco.co.uk
www.adco.co.uk

AdCo who are a leading supplier of industrial adhesives including hot melts, PVA and resin based timber bonding adhesives will be showing the brand new range of Lockfast engineering adhesives distributed in the UK by AdCo

This high quality range covers all production/ engineering requirements & consists of the following products

- Anaerobic threadlockers, pipe sealants, gasket makers
- Full range of high performance cyanoacrylates, activators & primers
- Epoxy repair sticks
- Structural adhesives
- Silicones

All products have full traceability & Lockfast are ISO:9001 accredited so for all bonding, sealing & maintenance applications Lockfast has a solution

ANOCHROME GROUP

Wood Lane, Fordhouses
Wolverhampton, West Midlands
WV10 8HN



t: 01902 397333
f: 01902 785372
e: enquiries@anochrome-group.co.uk
www.anochrome.co.uk

Anochrome Group

Anochrome Group is a specialist applicator of surface coatings and pre-applied technologies, serving diverse industries such as automotive, aerospace and telecommunications.

With over 50 years of expertise in the application of corrosion protective coatings for ferrous and non-ferrous components, Anochrome Group offer numerous finishes, including the latest hexavalent chromium free coatings, sacrificial zinc flakes and black topcoats.

A comprehensive range of pre-applied thread locking/sealing products is also available, as well as underhead sealants, including new duplex seals and patches in Precote® 15 and 200 materials.

All companies within the Group are accredited to ISO 9001 or TS16949, where applicable.

ASM FASTENERS LTD



Unit 2C, Wanlip Road, Syston
Leicestershire LE7 1PD

t: 0116 260 9738
f: 0116 260 4429
e: sales@asmfasteners.com
www.asmfasteners.com

ASM Fasteners Ltd is the Master Distributor for Tangless Inserts & Tooling for Kato Precision who is the world's Original manufacturer of Tangless wire threaded inserts.

Technical Support and Product Design/Introduction of our fasteners into new products/ projects is what we offer all our customers free of charge.

ASM Fasteners are able to satisfy the customer's needs by having one of the largest selection of Tangless & Tanged inserts & tooling Stock in the UK.

BS ISO EN9001:2008 approved, ASM can also supply other niche Fasteners like Key Inserts, NordLock, Roller Burnishing tools and Lee Products to the Aerospace, Motorsports, Defence, Nuclear & other Engineering Industries.

AXSON UK LTD



Unit 15 Studlands Park
Industrial Estate, Newmarket,
Suffolk CB8 7AU

t: 01638 660062
f: 01638 665078
e: sales@axson.co.uk
www.axson.com

Axson Technologies, global manufacturer of Structural Adhesives and Dielectric resins supply their range of products in the United Kingdom and Eire via Axson UK Ltd.

Manufacturing Epoxy, Polyurethane and Methacrylate Adhesives in the Adekit Cartridge Systems and in bulk for adhesives and Dielectric resins, Axson provide numerous solutions to bonding and encapsulation.

Many diverse Industries have benefited, from Bus and Vehicle construction, Marine, Electronics and multi-faceted GRP manufacturers. Bonding similar and dissimilar materials to each other from Aluminium, GRP, various plastics and coated surfaces, there is a grade of Polyurethane, Epoxy or Methacrylate adhesive to suit the application. In dielectrics, the range covers simple potting of capacitors and relays to Transformers and Filters.

BINDER FASTENER SYSTEMS (UK) LTD



Nile Street, Burslem,
Stoke on Trent ST6 2BA

t: 01782 525780
f: 01782 813207
e: sales@binderuk.com
www.binderuk.com

Binder Fastener Systems are the UK subsidiary of Gottlieb Binder GmbH & Co based in Germany. We are Europe's oldest, largest and most experienced manufacturer of technically advanced, reusable, reclosable fastener systems.

Our uncompromising attention to detail allied with our passion for problem solving means we are ideally positioned to help you with your fastener needs. Our production facilities in Germany are ISO 9001 : 2008 and 14001 : 2004 accredited. And our products are also OEKO-TEX Standard 100 approved to either class I or class II.

As a 7th generation family owned company we devote a large percentage of revenue to research and development which means we have a portfolio of products and adhesive systems to meet a very wide range of needs in almost any market. The sectors we supply are diverse and include orthopaedics, medical, cleaning, industrial, transport and construction including insulation and renewable energy.

BOLLHOFF DIRECT



Midacre, The Willenhall Estate, Willenhall, West Mids WV13 2JW

t: 01902 603934
f: 01902 603057
e: bdirect@bollhoff.com
www.bollhoff.com/uk

Bollhoff Direct is the UK sales division of Bollhoff GmbH, with over 100,000 Din Standard parts available from our German stocks and delivered direct to our UK customers.

Specializing in the more difficult to obtain parts, e.g. fine pitch bolts, non preferred lengths etc. in Steel, Stainless, Brass and Nylon, Bollhoff Direct couples the benefits of buying from a major European supplier with the convenience of a local distributor. Bollhoff Direct now also offer a new range of VaryBond chemical adhesives, lubricants and cleaning products and also a range of cutting discs. We hold the stock so that you don't have to.

BOLLHOFF FASTENINGS



Midacre, The Willenhall Estate, Willenhall,
West Midlands WV13 2JW

t: 01902 637161
f: 01902 609495
e: enquiries@bollhoff.com
www.bollhoff.com/uk

BOLLHOFF is a TS-16949 manufacturer of proprietary fastening systems exhibiting a range of innovative fastening solutions for joining sheet metal where no hole is required. Placing blind threads into thin and hollow section. Providing fasteners, which automatically compensate for tolerance stack-up. Push-On-Pull-Off reusable vibration and noise dampening fixings alongside quarter turn and bespoke plastic solutions.

In short BOLLHOFF provides a basket of innovative and cost effective solutions to the many and varied problems of fastening modern materials. We provide local technical support through a team of UK application engineers.

BTM (UK) AUTOMATION PRODUCTS LTD



Unit 11B, Sand Rd Industrial Estate
Great Gransden SG19 3AH

t: 01767 677001
f: 01767 677217
e: btmautomation@btconnect.com
www.clinching.co.uk

BTM, the market leader in providing specialist equipment for the joining of sheet metal assemblies and components using the patented clinching system TOG-L-LOC®. This technology is used throughout the automotive, white-goods, electronic, and construction industries as a cost effective way to join sheet metals. There are no additional fasteners, no heat, fumes, or sparks in the TOG-L-LOC® process which has proven very effective in joining pre-painted, coated, and dissimilar sheet metals. BTM TOG-L-LOC® Clinching is simply the best form of clinching on the market today. The exclusive action of the moving die blades allows the metals to flow into the interlock with minimal stress and force thus providing superior joint strength and tool life. From low production hand held equipment through to high speed high volume dedicated machinery we have a solution for you.

BUFAB UK LTD



Unit 14 Madeley Road,
Redditch, B98 9NB
t: 0844 4123201
f: 0844 4123202
e: chris.koumides@bufab.com
www.bufab.com

Produced in-house in Sweden, BUMAX is a range of stainless steel, high strength, acid-proof fasteners. The material used is a very high quality and consistent grade of A4/316LHiMo, its specific composition and our manufacturing knowhow combined gives BUMAX fasteners better corrosion resistance than standard A4, and is fully traceable. BUMAX 88 and 109 were developed to achieve the same yield and tensile strength values as grades 8.8 and 10.9 high tensile carbon steel fasteners. Combining its superior strength and corrosion resistance BUMAX really is a unique product and is often specified for the most extreme environments and demanding applications.

BUTTONFIX LTD



Unit A, 1 Britton Street, London EC1M 5NW
t: 020 8150 7190
e: info@button-fix.com
www.button-fix.com

Button-fix: the new, secret and secure panel fixing!

Button-fix is the new, extra strong, secret fixing for panels. Launched in March, it is already proving a great success with furniture manufacturers, shop fitters and interior fit-out companies.

Button-fix is very easy to align and fit with the Buttons locking safely home with a 'click'. Now there is a choice of two Fixes to cater for a wide range of panel configurations — how will you use the Button-fix system?

Designed, tested and manufactured in the UK to the highest standards, Button-fix works with a wide variety of panel materials and thicknesses.

COOKE BROTHERS LTD



Northgate, Aldridge, Walsall WS9 8TL

t: 01922 740011
f: 01922 740003
e: sales@cookebrothers.co.uk
www.cookebrothers.co.uk

Cooke Brothers, one of the UK's leading Hinges and Hardware manufacturers, are showcasing the full range of Continuous Hinges, High performance CE marked and fire rated hinges together with a wide range of specialist products for industrial applications.

Based in the heart of the West Midlands, Cooke Brothers are well-established suppliers of high quality hinge products and bespoke precision fittings to a wide variety of industries including Automotive, Engineering, Lighting, Aerospace and the Defence markets.

The company provides a complete design and development and manufacturing facility, incorporating in-house tool making, the latest in computer guided laser punch presses and engraving technology.

ELESA (UK) LTD



26 Moorlands Estate, Metheringham, Lincolnshire LN4 3HX
t: 01526 322670
f: 01526 322669
e: sales@elesa.co.uk
www.elesanow.co.uk

See Elesa's new catalogue containing 2000 new products covering hinges, level indicators, cam levers, magnets, indexing plungers, fork and spherical rod ends and vibration damping elements. 150,000 codes in one catalogue especially for engineering designers.

There are many new operating elements including wing screws and lobe knobs, adjustable handles, clamping nuts and cam levers.

New machine elements include split set collars – levelling elements – CFV four position hinge – latches and snap locks.

A free copy can be obtained from the stand or may be ordered at: www.elesanow.co.uk/catalogues.

EUROBOND ADHESIVES LTD



Bonham Drive, Eurolink Ind. Estate,
Sittingbourne, Kent ME10 3RY

t: 01795 427888
f: 01795 479685
e: sales@eurobond-adhesives.co.uk
www.eurobond-adhesives.co.uk

Eurobond Adhesives have been supplying high performance adhesives, adhesive tapes, UV light systems and dispensing equipment for over 28 years. We have a wealth of experience to draw on from many market sectors including the automotive, aerospace, medical device, electronics, manufacturing, engineering, architectural metalwork and retail.

Our extensive range includes Penloc 2-part structural adhesives, Vitalit UV light curing adhesives, Honle UV light systems, Elecolit conductive adhesives and Cyanolit instant adhesives. In addition we will be presenting the Eurobond range of acrylic tapes and anaerobic threadlockers. liquid gaskets and metal epoxy stick adhesives.

To discuss your specific application visit the Eurobond Adhesives stand.

F A PARKES LTD



Unit 4 Acorn Court, Butts St., Leigh
Lancs WN7 3AE

t: 01942 681996
f: 01942 681997
e: sales@faparkes.co.uk
www.faparkes.co.uk

FA Parkes Ltd is a leading manufacturer and distributor of high quality locks, handles, hinges, gasketing, rod sets and accessories for the industrial field. Our range also includes a full variety of gas stays, which can be custom designed to your requirements.

As well as designing, modifying and manufacturing products for speciality and niche markets we are the UK's leading distributor for Lowe and Fletcher, Weston Body Hardware, Stabilus, Dirak and Pinet. FA Parkes Ltd offers innovative services to support our customers including vendor managed inventory, real time stock visibility and ordering facilities together with a second to none customer service team enabling you to best meet your customers' needs.

Our product range and service makes FA Parkes Ltd your partner of choice for industrial hardware.

F A PARKES LTD



Unit 4 Acorn Court, Butts Street, Leigh, Lancs WN7 3AE

t: 01942 681996
f: 01942 681997
e: sales@faparkes.co.uk
www.faparkes.co.uk

FA Parkes Ltd are proud to be associated with Stabilus, Dirak and Pinet and to promote these brands at this years FAST exhibition we have taken two stands.

There's lots to see with our premier range of brands on display and we offer both standard and custom designed products to meet most requirements.

Make FA Parkes your choice of partner for industrial hardware and reap the benefits that our solid support provides, come and see us on the 18th October or contact our customer support team now.

FATH COMPONENTS



6 Pegasus Court, North Lane Aldershot,
Hants. GU12 4QP

t: 01252 346610
e: david.hayes@fathcomponents.com
www.fathcomponents.com

FATH is an international company that produces quality mechanical hardware, particularly T nuts, levelling feet, threaded inserts, latches, locks, hinges and handles.

Please visit our stand where our representatives, David Hayes and Emma Berriman will be presenting the FATH Lift Castor - one turn of the accompanying hydraulic pump is all it takes to lift your equipment smoothly and evenly for effortless relocation across any industrial floor.

FATH has manufacturing facilities in Germany, United States and Asia and is able to ensure the reliable supply of FATH products around the world. FATH is dedicated to providing products backed by excellent customer service and technical support.

G & B PROJECTS COMPANY



Barnards Green, Malvern WR14 3LY

t: 01684 574367
 f: 01684 560225
 e: andrew@gandbprojects.co.uk
www.gandbprojects.co.uk

The UK's leading manufacturer and stockist of Pillars and Spacers, G&B Projects, will be displaying its extensive range of robust and highly adaptable nylon pillars at the FAST & IASE Exhibition Birmingham 2012. The company's acclaimed standard range comes in round, hexagonal and micro specifications. Practically any body length can be supplied with metric thread sizes from M2.5 to M12 as well as imperial and US versions. In addition, G&B can manufacture custom sizes and specifications on request with fast turnaround, in many cases at no extra cost.

G&B pillars feature an innovative insert design and locating process. Thanks to the exceptional strength and resilience of the solid body style and brass insert design, all nylon pillars from G&B are inherently resistant to shock which can cause inferior products to fail. G&B products offer increased strength over wholly plastic parts and excellent electrical insulation properties not attainable with wholly metal parts.

Also on show at the FAST Exhibition from G&B Projects:

- Nylon and brass spacers (clearance and threaded)
- Snap-in nylon pillars and spacers
- Brass and Steel pillars
- Headed insulating bushes Metric screws, nuts and washers
- Screwlock assemblies
- Earthing bars

GEORGE EMMOTT (PAWSONS) LTD

Wadsworth Mill, Oxenhope,
Keighley, West Yorkshire BD22 9NE

t: 01535 643733
 f: 01535 642108
 e: mail@emmottsprings.co.uk
www.emmottsprings.co.uk

EMMOTT (PAWSONS) LTD designs and manufactures a wide range of springs, clips, washers, pressings and specialist products for most industries and applications.

In addition to standard products, George Emmott works in close partnership with its customers in developing bespoke solutions to meet individual requirements. The company has always maintained an ongoing programme of investment in production equipment and machinery, using in-house expertise to build purpose-designed machines where necessary to fulfil specific manufacturing applications. Capacity is therefore flexible and can cater for prototyping as well as large batches and small production runs. Fast turn-round and accurate delivery ensures that where necessary, even very short lead times can be accommodated. Quality is of the utmost importance and George Emmott is certificated to BS EN ISO 9001:2000, with all manufacturing and administrative process and procedures being carefully monitored.

GESIPA BLIND RIVETING SYSTEMS LTD



Dalton Lane, Keighley, West Yorkshire BD21 4JU

t: 01535 212200
 f: 01535 212232
 e: info@gesipa.co.uk
www.gesipa.co.uk

With over 50 years of manufacturing and application expertise Gesipa Blind Riveting Systems are world leaders in producing an extensive range of rivets, rivet nuts, rivet nut studs and bespoke based solutions. With ISO 9001, ISO14001 and ISO/TS 16949:2009 accreditation, technical expertise, advanced machinery, quality control system and professional sales services, Gesipa continues to secure its reputation within the industry as the preferred supplier.

Product Range	Rivet Nuts	FireBird®
	Hand Riveters	
	Lazy Tong and Lever	
Blind Rivets	Riveting Tools	New Product Range
Poly Grip®	AccuBird®	
MEGA GRIP®	PowerBird®	Rivet Nut Studs
BULB-TITE®	TAURUS-Series	FireFox®
TRL_FOLD®	TAUREX 1-6	
G-Bulb		

GTMA

47 Birmingham Rd, West
Bromwich, West Midlands,
B70 6PY

t: 0121 601 6350
 f: 0121 601 6378
 e: admin@gtma.co.uk
<http://www.gtma.co.uk>

GTMA is a UK-based trade association representing leading companies in precision engineering, rapid product development, toolmaking, tooling technologies, metrology and other critical manufacturing related products and services. We have a committed strategy to focus on major market sector opportunities, from aerospace and automotive to medical and oil and gas.

HENKEL LTD

LOCTITE®

Technologies House, Wood Lane End, Hemel Hempstead, Herts HP2 4RQ
 t: 01442 278000
 f: 01442 278071
 e: technicalservice.loctite@uk.henkel.com
 www.loctite.co.uk

Henkel is the world market leader in adhesive and sealants, supplying many different manufacturing industries. At FAST 2012, Henkel focuses on its latest 'world first' – the Loctite Health and Safety adhesive range that covers many applications. The products are designed to make the COSHH assessment and acceptance process for engineering adhesives as easy as possible without any increase in cost price. The Loctite brand has a very strong health and safety ethos with its R&D being driven by sustainability and responsibility. Continuous development has led to the introduction of the hazard-label-free Loctite 2400 and 2700 threadlocking products and now these have been joined by others with similar credentials. In addition to dedicated threadlocking adhesives the new Loctite Health and Safety range also encompasses threadsealing, gasketing and retaining. More information: www.loctitesolutions.com



HENROB LTD



Unit F Tyburn Trading Estate, Ashold Farm Road, Birmingham B24 9QG
 t: 0121 382 7338
 f: 0121 382 4203
 e: sales@henrobdirect.co.uk
 www.henrob.com

Henrob design and manufacture self pierce riveting solutions for joining a wide range of materials in a variety of diverse applications. The increasing use of coated lightweight high strength materials, has led all industries to reexamine traditional methods of assembling components. As welding of these materials is difficult, and assembly using conventional rivets is slow and costly, the benefits of a process that combines high joint integrity with rapid assembly times become obvious. SPR is fast (2 seconds). With no drilling, heat, fumes, or swarf. The operation is low noise, and economical. Visit our stand to organise a free on-site demonstration.

IGUS (UK) LTD



51A Caswell Road, Brackmills Industrial Estate,
 Northampton NN4 7PW
 t: 01604 677240
 f: 01604 677245
 e: maldridge@igus.co.uk
 www.igus.co.uk

igus® develops industry-leading Energy Chain® cable carriers, Chainflex® continuous-flex cables, iglidur® plastic plain bearings, DryLin® linear bearings and guide systems and igubal® spherical bearings. These seemingly unrelated products are linked together through a belief in making functionally advanced, yet affordable plastic components and assemblies. With plastic bearing experience since 1964, cable carrier experience since 1971 and its own line of flexible cable since 1989, igus® provides you with the right solution based on a very broad selection of standard components, from stock. No minimum order required.

INTERNATIONAL ENGINEERING CO LTD



First Choice Solutions®

Harwell Road, Nuffield Estate,
 Poole BH17 0BD

t: 01202 339559
 f: 01202 680101
 e: info@iecltd.co.uk
 www.iecltd.co.uk

Loosening connections? IEC Lock Systems has the solution - the safe lock system. Tested and approved by leading international test institutes we can give 100% guarantee on all your critical connection problems. The IEC Lock System has an anti theft design, highly suitable for use in public areas where vandalism and/or theft can be dangerous (road signs, billboards, crash barriers etc). How does it work? The IEC Lock System converts a horizontal movement into a vertical force, through the wedge design, while the patented ratchet teeth bite into the surface. BENEFITS: Safer, Better shock resistance, 100% control, anti theft design, re-usable, 100% vibration resistant and easy to undo.

JENTON INTERNATIONAL UK



9/10 Ardglen Industrial Estate,
Ardglen Road, Whitchurch,
Hampshire RG28 7BB

t: 01256 892194
f: 01256 896486
e: rlittle@jenton.co.uk
www.jentonuv.co.uk

JentonUV are specialist engineers and developers of UV curing systems, from medical grade UV Spot Cure systems to industrial UV for large adhesive and coating applications. Jenton supply medical, aerospace and industrial UV adhesives in acrylic and epoxy formats and have in-house laboratory facilities where customers can test performance under a selection of UV sources. On the lamp front, Jenton supplies LED, arc lamp and microwave lamp UV sources in addition to UV measurement equipment and custom UV conveyors and product handling systems.

LEE SPRING LTD



Latimer Road, Wokingham, Berks RG41 2WA

t: 0118 978 1800
f: 0118 977 4832
e: sales@leespring.co.uk
www.leespring.co.uk

From 10 Springs to 10 million Springs, Stock parts or Custom Designs. Lee Spring offers the complete package.

Whether it's an off the shelf product, available for same day despatch, or a bespoke spring design for a specific application.

Now with over 19,000 off-the-shelf product types, including around 2000 new Metric additions. From round wire compression, die, extension, torsion and REDUX™ wave springs to innovative Plastic Composite™ and Bantam™ miniature compression springs.

Our experienced Customer Service team is ready to help with catalogue spring selection and local engineering professionals can work with you to turn your ideas into reality.

LIQUID CONTROL LTD



Stewarts Road, Finedon Industrial Estate, Wellingborough NN8 4RJ

t: 01933 277571
f: 01933 440273
e: sales@liquidcontrol.co.uk
www.liquidcontrol.co.uk

Liquid Control provides resin mixing solutions. For over 40 years Liquid Control Ltd have been a leader in the design and manufacture of precision single component dispensing and multi- component metering, mixing and dispensing equipment for liquid and paste resin systems. Our depth of knowledge and understanding for processing materials such as Epoxies, polyurethanes silicones etc and our detailed consideration of our customer's dispensing application needs ensures the equipment we manufacture will be fit for purpose for many years. Our UK manufacturing facility supplies equipment around the world through our 25 overseas sales and support distribution partners, in a variety of industries from electronic encapsulation to boat building, from solar panel manufacture to wind turbine blade infusion. Liquid Control provides resin mixing solutions.

LOHMANN TECHNOLOGIES (UK) LTD



The Bonding Engineers.

25 Kelvin Drive, Knowlhill, Milton Keynes MK5 8NH

t: 01296 337888
e: info@lohmann-tapes.co.uk
www.lohmann-tapes.co.uk

Lohmann is one of Europe's most respected and successful manufacturers of technical bonding solutions, with 160 years experience.

Lohmann continues to receive significant increases in demand for cost saving solutions from UK manufacturers and continue to deliver these savings.

Lohmann's key markets are:

Transportation,	Medical,	Communications
Consumer Goods,	Building &	and Graphics.
Electronics,	Construction,	
Security,	Mobile	

Expert advice is available from our technical team in the UK as well as our German HQ. Solutions are developed and converted locally; logs, rolls, spools & die cuts, using a variety of adhesive suppliers and sourced materials

Lohmann Adhesive Tapes Systems is increasingly becoming the supplier of choice for many. As a technical specialist Lohmann offer bespoke solutions, 85% of sales are tailor-made to an individual customer's requirement, manufactured locally in the UK.

You could be surprised what an adhesive tape system can do!

METTLER TOLEDO



64 Boston Road, Beaumont Leys,
Leicester LE4 1AW
t: 0116 235 7070
f: 0116 236 6399
e: enquire.mtuk@mt.com
www.mt.com

METTLER TOLEDO UK is part of the global METTLER TOLEDO group, the leading supplier of quality weighing and measuring solutions. The organisation is the world's largest manufacturer and marketer of weighing technologies for use in laboratory, industrial and food retailing environments. METTLER TOLEDO also holds key market positions for various related analytical instruments and is a principal provider of automated chemistry systems, as used in the discovery and development of new drugs and chemical compounds. In addition, METTLER TOLEDO is also the world's largest manufacturer and provider of metal detection and X-ray product inspection technologies, for use across the international production and packaging sectors. The business maintains a premier position in certain process analytics applications.

From its headquarters in Leicester, METTLER TOLEDO UK is able to offer a full range of weighing equipment for use in laboratory, manufacturing, industrial, food preparation and retail applications, as well as comprehensive service, support and calibration capabilities.

NELSON STUD WELDING UK



47/49 Edison Rd., Rabans Lane Ind. Est., Aylesbury, Bucks HP19 8TE

t: 01296 433500
f: 01296 487930
e: enquiries@nelson-europe.co.uk
www.nelson-europe.co.uk

Nelson Stud Welding is the original inventor, manufacturer and supplier of stud welding equipment and weld studs. We supply equipment and studs to the automotive, shipbuilding, construction and metal fabrication industries and provide a wide range of cold formed weld studs in steel, stainless steel and aluminium. Our latest range of stud welding equipment, which includes two lightweight inverters, is designed to the latest digital technology. This allows for accurate control of the welding process and gives unparalleled results. Our equipment range is capable of welding studs from 3mm diameter up to 25mm diameter. Various models are available for welding to thin sheet as well as to heavier gauge material. Nelson Stud Welding is a Doncasters Group Limited company and therefore we will be promoting performance critical, cold formed and deep hole drilling fasteners from EBC Industries and Ferry Cap. In addition information will be available on precision forged and machined components from Specialty Bar Products Company. Visit us today for further information.

NORD-LOCK LTD

**Bolt securing systems**

Room 9 Main Building, Aspire Business Centre, Ordnance Road,
Tidworth SP9 7JR

t: 01980 847129
f: 01980 847674
e: enquiries@nord-lock.co.uk
www.nord-lock.com

The Nord-Lock Group is a world leader in bolt securing systems. We offer a unique combination of bolting expertise and a wide product range, including wedge-locking solutions and Superbolt tensioners.

New technologies and demands are creating unique design challenges and now the bolting experts at Nord-Lock have the answer. Utilizing a unique multifunction design the new Nord-Lock X-Series washers offer the highest security against both spontaneous bolt loosening and slackening. Please visit our stand to find out more about this new evolution in bolt security.

The Nord-Lock Group looks forward to being your partner in bolt optimization.

PROFIL UK LTD



Unit 6, Whitwick Business Centre, Stenson Road, Coalville,
Leicestershire LE67 4JP

t: 01530 276515 • f: 01530 276516
e: adrian.ellis@profil.eu
www.profil.eu

PROFIL develops pierce nuts and studs which are fastened to metal components using a riveting process. We are a system supplier who also constructs automated feeding equipment which is customized to meet the production requirements of our customers. The economic advantages of using the PROFIL system in industrial manufacturing is documented by a multitude of applications, mainly in automotive, appliance and construction fittings industries. All major automobile manufacturers and suppliers are among our customers. Cost savings of at least 30% can be achieved over equivalent welded processes. The quality of the resulting fixing is also superior to welded fasteners. PROFIL fastener technology is suitable for sheet metal components in Aluminium through to high strength steels up to 1500Mpa.

PROTEX FASTENERS LTD



Arrow Road, Redditch, Worcestershire B98 8PA
 t: 01527 63231
 f: 011527 66770
 e: sales@protex.com
 www.protex.com

Protex Fasteners prides itself in the design and manufacture of precision over centre toggle fasteners, latches and accessories. We operate a Quality Management System, documented in our Quality Manual and Quality Procedures. All manufactured parts conform to our Quality Management System, and these systems are audited regularly by NQA and comply with ISO 9001:2008. The entire range of Protex products is manufactured at our works in Redditch, UK. The full standard range of items shown on our price list are normally available from stock. Prompt delivery is offered worldwide.

RICHCO INTERNATIONAL CO LTD



Richco House, Springhead Enterprise Park, Springhead Rd.,
 Gravesend, Kent DA11 8HE
 t: 01474 327527
 f: 01474 327455
 e: sales@richco.co.uk
 www.richco-int.com

Richco designs, manufactures and distributes one of the world's most comprehensive ranges of innovative component solutions, specialising in fasteners, circuit board hardware, cable management products, fibre optic components and telecommunications accessories. Richco will be exhibiting our standard fastening products including: PCB and cable fasteners, rivets, feet, LED spacers, fan accessories, cable ties, EMI shielding products and over 2000 new products. Richco also provide specialist fixings and fastenings, using our comprehensive design and manufacturing service to exactly meet customers' requirements.

SAVIGNY ODDIE LTD



Wallows Industrial Estate, Wallows Road, Brierley Hill,
 West Midlands DY5 1QA
 t: 01384 481 598
 f: 01384 482 383
 e: info@savigny-oddie.co.uk
 www.savigny-oddie.co.uk

Savigny Oddie Ltd is a specialised fastener company based in the West Midlands, the Oddie Quarter Turn Quick Release Fastener can be used for securing panels or components that have to be speedily and easily removed for essential servicing or replacement work to be carried out. The extensive range of fasteners are available in various head configurations, finishes and materials. We can offer standard stock items or manufacture to bespoke customer requirements. Savigny Oddie has also manufactures a wide range of carrying handles for use on containers or boxes available in Mild Steel, Stainless Steel or Aluminium. For further details please visit our website www.savigny-oddie.co.uk

SIL-MID LTD



Our innovation, your solution

2 Roman Park, Roman Way, Coleshill B46 1HG
 t: 01675 432850
 f: 01675 432870
 e: info@silmid.com
 www.silmid.com

Established in 1979, Sil-Mid Ltd is a leading international distributor of Adhesives, Sealants, Lubricants, Silicones, Oils, Greases, Cleaning Agents and Surface Treatments. With over thirty years of experience Sil-Mid has an extensive range of specialist products.

Through our technical expertise and vast experience we offer added value to all global customers, we drive down unnecessary costs and save valuable time by providing rapid procurement from one supplier.

With a comprehensive portfolio of 14,000 products from 400+ leading manufacturers, we offer custom repacks and source materials globally.

Visit www.silmid.com for a full online ordering facility; trade and contract pricing available.

SPECIALTY FASTENERS AND COMPONENTS LTD



Unit D Seymour Wharf, Steamer Quay Road, Totnes, Devon TQ9 5AL

t: 01803 868677
f: 01803 868678
e: sales@specialty-fasteners.co.uk
www.specialty-fasteners.co.uk

Specialty Fasteners, an ISO9001:2008 approved company, is a designer, manufacturer and distributor of quick release fasteners and hardware for the Defence, Aerospace and Industrial markets. SFC design and manufacture the AeroCatch range of panel fasteners used in motorsport applications worldwide, Push Turn Fasteners, Snap-in Captive and SEMS screws for the electronics market. SFC distributes the complete Alcoa Fastening Systems range which includes the well known brand names Camloc and Tridair. Hydraflow fuel couplings and hose assemblies for potable water, breathing oxygen and cooling fluids, Quick Release Pins, Accuride drawer slides and Camloc gas springs complete the range.

SPIRALOCK OF EUROPE



Stanley Black & Decker, Unit H Gowerton Road, Brackmills Industrial Estate, Northampton NN4 7BW

t: 01604 827216
f: 08701 670670
e: sl-europe@spiralock.com
www.spiralock.com

Spiralock has re-engineered the standard (female) internal thread form and added a 30° wedge ramp at the root of the thread. Through this unique design, Spiralock® thread form is exceptionally resistant to thread loosening and stripping, caused by transverse vibration. It is also free-spinning and reusable. Spiralock products include flange nuts, self-clinching nuts, wire thread inserts, threaded inserts, taps and gages, threading inserts and thread milling cutters. Eliminating the need for secondary locking methods, Spiralock provides reliable threaded fastening solutions for critical applications in aerospace, military, truck, automotive, diesel engine, medical, farm, construction, oil exploration and other industries.

SPRINGMASTERS LTD



Arthur Street, Redditch B98 8LF

t: 01527 521000
f: 01527 528866
e: sales@springmasters.com
www.springmasters.com

Springing forward with a range from 0.1mm to 50mm The Springmasters Group, incorporating Valley Spring and Belleville Springs, is one of the leading and most diverse manufacturers of springs in the UK. As a result of multi million pound investment, the group offers a comprehensive range of compression, extension, torsion and flat metal springs. The Group's 50,000 square foot manufacturing facility, encompassing two sites, offers customers CNC coiling from a wire diameter of 0.1mm to 20mm in addition to lathe coiling up to a diameter of 50mm. The allied product range includes wire forms, clips, disc springs, hose clamps and circlips, which are available from the extensive stock range at the Redditch warehouse. Manufacturing facilities are complemented by in-house design and development teams and the ability to offer rapid prototyping. This investment and technical expertise consolidates The Springmasters Group's position at the forefront of spring manufacturing in the UK, offering competitive prices without compromising on quality.

STAYTITE LTD



Coronation Rd,
Cressex Business Park, High Wycombe, Bucks HP12 3RP

t: 01494 462322
f: 01494 464747
e: fasteners@staytite.com
www.staytite.com

Staytite has been dedicated to meeting all your fastening requirements for over 30 years. Our unrivalled knowledge, industry experience and outstanding customer service has come to be regarded as the best in the industry. Our experience makes us the premier supplier of All Metal Self Locking Nuts. We are the number 1 trusted source for both technical advice and extensive range of solutions to the age old problem of sourcing the right nut for the right application at the right price, not to mention availability from stock. Our extensive range of All Metal Lock Nuts starts from the most basic deformed thread type, to the complete engineered solution offered by the use of the Hardlock Nut.

tesa UK LTD



Yeomans Drive, Blakelands, Milton Keynes MK14 5LS

t: 01908 211333
f: 01908 211555
e: ukenquiry@tesa.com
www.tesa.co.uk

tesa® will showcase its range of double sided acrylic adhesive tapes with optimum viscoelasticity for constructive bonding applications – tesa® ACXplus.

tesa® ACXplus offers a viable alternative to traditional mechanical fastening methods, offering significant advantages which can be seen in its bonding strength, stress dissipation and resistance to the elements.

As part of its tesacohesion philosophy which focuses on people, products, processes and performance, tesa is inviting visitors to bring their applications to the stand to discuss how they can help. Visitors will also have the chance to see other products within the tesa® range, including a core selection of double sided foam and filmic tapes, heat activated film and laser labels for tamper evident security marking.

TFC CAVALIER FASTENERS



Westgate, Aldridge, Walsall, West Midlands, WS9 8EX

t: 01922 740400
f: 01922 744313
e: cavalier@tfc.eu.com
www.tfccavalier.com

TFC Cavalier Fasteners based in Aldridge, Walsall, have established themselves as a highly professional and flexible company traditionally supplying construction fixings and threaded fasteners. Their stock portfolio also includes sheet metal fasteners, threaded inserts, alignment washers and glazing products from some of the world's leading manufacturers. As a member of the TFC group, full DLF and Kanban services are now available from this site in the Midlands area. In addition, TFC's flat wire Spirolox Rings and Wave Springs will also be on display. These unique products, which offer space saving advantages over conventional retaining rings & coil springs, are readily available in a wide range of sizes and materials. www.tfccavalier.com

Three Bond Europe S.A.S (UK Branch)



5 Newmarket Court,
Kingston, Milton Keynes MK10 OAG

t: 01908 285000
f: 01908 285001
e: info@threebond.co.uk
www.threebond.co.uk

ThreeBond are a global Japanese manufacturer of adhesives and sealants with sales in excess of £400 million. ThreeBond products are used by many of the world's best known companies in manufacturing sectors including automotive, electronic, engineering, construction and consumer. Included in ThreeBond's range of over 4000 products are liquid sealants, adhesive sealants, anaerobic, pressure sensitive, UV light curing, cyanoacrylate, electrically and thermal conductive adhesives, one and two part epoxy resins. ThreeBond also offers a range of specialist dispensing and application equipment to better utilise the advantages offered by liquid adhesives and sealants. At our facility in Milton Keynes ThreeBond also offer a comprehensive Precoat fastener adhesive and sealant coating service. ThreeBond - take a look at our world

TOTAL AIR TOOL SERVICES UK



Head Office Unit A Princes Drive Industrial Estate,
Kenilworth, Warwickshire CV8 2FD

Southern Office Unit 1 White Waltham Airfield,
Maidenhead, Berkshire SL6 3NJ

t: 01926 857193
e: info@totalairtool.co.uk
www.totalairtool.co.uk

NEW FROM TOTAL SUPERPOWER FOR INDUSTRY Total will be launching the all NEW LMS 8 series impact wrenches. The New Atlas Copco LMS 8 delivers true raw power which enables extremely fast tightening and loosening in even the most difficult application. The innovative and unique Grease Retaining System (GRS) ensures maximum tool performance combined with extremely long service intervals. For an impact wrench the LMS 8 has extraordinarily low vibration levels and very high power to weight ratio which can provide as much as 5.500 Nm of torque from a tool weighing only 15Kg. See the tools on stand

UNIFAST FASTENING SYSTEMS LTD



Unit 5 Woodlea Park, Four Marks,
Alton, Hampshire GU34 5AZ

t: 01420 563333
f: 08707 627964
e: sales@unifast.co.uk
www.unifast.co.uk

Unifast specialise in captive threaded and quick release fasteners. We provide solutions that will:

- gain improved productivity
- enhance product design
- benefit manufacturing costs
- increase profitability

KAPti-nut – a high strength, captive threaded fastening system for sheet metal.

A cleaner, safer and environmentally friendly alternative to weld nuts.

FAST- turn – a quick acting fastening system used on access panels and machine guards. A simple quarter turn to click the fastener securely into place – saving you time and money. Unifast - excels in the design and development of custom fasteners. We offer our clients innovative, economic and reliable fastening solutions.

VIKING TAPES & ADHESIVES LTD



Unit 1 Coronation Business Park,
Hard Ings Rd., Keighley,
West Yorkshire BD21 3ND

t: 01535 610373
f: 01535 610801
e: sales@vikingtapes.co.uk
www.vikingtapes.co.uk

Founded in 1989 Viking have over 40 years experience in providing Adhesive solutions to Industry. They are one of 3M's major Industrial Wholesalers and their principle partner for the supply of 3M Tapes and Adhesives on line. www.vikingtapes.co.uk The Viking website provides a wealth of Technical Information with easy to follow selection guides ensuring you obtain the correct product for your application. Viking also provides technical advice, a sampling service and a technical telephone helpline. Come and talk to our Team at the exhibition. We can recommend a wide range of products and using our specialist Conversion service can tailor them to meet your exact requirements. We help tens of people everyday either on line or in person with Adhesive solutions. Talk to us...

WDS COMPONENT PARTS LTD



Richardshaw Road, Grangefield Industrial
Estate, Pudsey, Leeds LS28 6LE

t: 0113 290 9852
f: 0845 601 1173
e: sales@wdsLtd.co.uk
www.wdsLtd.co.uk

Formed in 1952, WDS is the UK's leading manufacturer of Standard Parts and Machine Accessories, for use in OEM Machine Building & Maintenance.

WDS will be displaying Castors, Handles, Clamping Products, Toggle Latches, Gas Struts, Hinges and many more, together with NEW PRODUCTS added this year.

We have over 15,000 products currently held in stock, which are available in various materials, including Steel, 316 and 303 Stainless Steel, Plastic, Cast Iron and others. All product information is available online, this includes line drawings and 2D/3D models in any current format. WDS does not operate with any small order surcharges.

ZYGOLGY



2 Barnes Wallis Court,
Wellington Road
High Wycombe, Bucks
HP12 3PS

t: 08458 121220
f: 08458 121221
e: sales@zygology.com
www.zygology.com

Zygology is the UK's largest authorised distributor for Southco quick access hardware, Avdel blind rivets, PEM self clinch fasteners and Pemsertter Installation presses. We are also main authorised distributors for Gesipa riveting systems and BBA - manufacturers of high performance and special purpose rivet nuts. To cater for all needs we also carry an extensive range of ancillary products including our own range of rivet nuts.

To ensure that we provide a complete service, we have a team of experienced sales engineers covering the entire country. If you have an assembly problem that you are not sure how to resolve, we will be pleased to take a look at it for you. To assist with product selection we can provide samples, technical advice, on site demonstrations and line trials. We pride ourselves on our problem solving abilities; and guarantee to go the extra mile to help you to reduce your assembly costs.

COMING SOON!



www.fastener-buyer.co.uk

www.adhesives-buyer.co.uk

FAST Magazine's Guide to UK
fastener and adhesives suppliers

Thinking Plastic Fasteners?

Choose the world's premier manufacturer of quality plastic fasteners.



Think

micro plastics,[®] international

Latin America

micro plastics international S.de R.L.de C.V.
Carretera a Huinala #510 Fracc. Ind. San Andres
CP 66640 Apodaca, N.L. México
Tel (52) 81 8000 3760 Fax (52) 81 8000 3766
mpventas@microplastics.com

United States

micro plastics inc.
11 Industry Lane
Filipin, AR 72634 USA
Tel (870) 453 2261 Fax (870) 453 8676
mpsales@microplastcs.com

Europe

micro plastics international Ltd.
Unit 2 Henley Ind. Park, Henley Road
Coventry CV2 1ST United Kingdom
Tel +44 (0) 2476614320 Fax +44 (0) 2476614831
sales@microplastics.co.uk